

LONDON:  
HARRISON AND SONS, PRINTERS IN ORDINARY TO HER MAJESTY,  
ST. MARTIN'S LANE.

ON THE  
DEVELOPMENT AND DISTRIBUTION  
OF  
PRIMITIVE LOCKS AND KEYS.

---

ETYMOLOGY of words for Locks and Keys:—"Klu," the Greco-Italian base, to lock (FICK), from the Sanskrit "Klu," to move (BENFEY and MONIER WILLIAMS); "Klavi," key (FICK); "κλείς," Greek, a key; "κλειστρον," Greek, a bolt or bar; "Clastrum," Latin, a lock, bar, or bolt; "Claudo," Latin, to close or shut; "Clausum," Latin, an enclosed space; "Clausura," Latin, a castle; "Clavis," Latin, a key; "Clavus," Latin, a nail; "Clef," French, a key; "Clou," French, a nail; "Clo," Gaelic, a nail, pin, or peg; "Clo," Irish, a nail or pin; "Glas," Irish, a lock; "Clo," Welsh, a lock; "Clar," Bourguignon, a key; "Clau," French provincial, a key; "Clav," old Spanish, a key; "Chiave," Italian, a key; "Chave," Portuguese, a key; "Close," English, to shut. From the same root, "Klu," to move, comes also "Sklu" (SKEAT), from which is derived the Teutonic "Slut," to shut, and from thence the Dutch "Slot," a lock, and also a castle, from "Sluiten," to shut; old Friesic "Slot," from "Sluta," to shut; Low German "Slot." Thus also the English provincial word "Slot," a bolt; "Schlos," German, a lock, and also a castle; "Schlüssel," German, a key. From the Latin "Sero," to put, comes "Sera," Latin, a movable bar or bolt; "Serrure," French, a lock; "Serratura," Italian, a lock. The French word "Verrou," a bolt; Wallon "Verou" or "Ferou;" Bourguignon "Varullo;" Provincial "Verroth," "Berroth," and "Ferroth;" Portuguese "Ferrotho." The forms in "f" appear to indicate a derivation from the Latin "ferrum," iron. The English word "Lock" is derived from the Teutonic base, "Luck," to lock (FICK); "Loc," Anglo-Saxon, a lock; "Lock," Friesic, a lock; "Lukke," Danish, a lock; "Loca," Icelandic, a lock or latch, or the lid of a chest; "Lock," Swedish, a lid; "Loke," Wallon; "Luycke," Flemish; "Loquet," French, a catch. In Early English it was pronounced "loke" (SKEAT). The English word "Latch" is probably the same as the Danish "Laas," a lock; "Las,"

Swedish, a lock ; "Luchetto," Italian, a latch. SKEAT derives it from the Anglo-Saxon word "lœccan," to seize ; in Early English it was pronounced "Lacche," and he suggests the probability of its being derived from the Latin word "Laqueus," a snare, but this is doubtful. "Hasp," English, is derived from the Teutonic base, "Hapsa;" "Hæpsa," Anglo-Saxon; "Hespa," Icelandic; "Haspe," Danish; "Haspe," Swedish; "Haspe," German. "Moraillon," the French word for "hasp," is of uncertain origin, but LITTRÉ supposes it to be derived from the provincial "Mor," a muzzle, probably the French word "Mors," a bit ; "Morsum," Latin, a bit or a little piece ; "Morsus," Latin, a bite, as well as the English "Muzzle" and "Nozzle," are all derived from the same root. "Clef bénarde," a key that is not piped (*forée*) (HAMILTON and LEGROS) or furnished with grooves, and which can be opened from both sides, is from "Bernard," which in old French signifies a fool, hence a "clef benarde" or "bénarde" is an inferior kind of key (LITTRÉ). The English word "Key" was derived from the Anglo-Saxon "Cæg" by the change of "g" into "y;" old Friesic "Kai" and "Kei." The English word "Bolt," which is now applied to the most primitive form of the mechanism, and probably the one from which the others took their origin, appears to have been obtained from the Anglo-Saxon word "Bolt," a catapult. Thus we have the Danish "Bolt," an iron pin ; "Bout," Dutch, a bolt or pin ; "Bolz," German, and it appears to have been adopted from its resemblance to the bolt or arrow used with the catapult. CRABB ('*Technical Dictionary of Arts and Sciences*') thinks it comes from the Latin "Pello," to drive, and the Greek "Ballo," to cast, and that it has thus been applied to anything shooting, as a bolt of a door, or a bird bolt, whilst SKEAT supposes it to have been named like "bolster" from its roundness.

The word "Padlock" is important in relation to our subject. This kind of lock is especially suitable as a fastening for baskets and saddle bags ; being a hanging lock, less liable to injury from knocks than a fixed lock, it is used in preference to this day for travelling purposes. The word "Pad" is a provincial Norfolk word used for "Pannier" (HALLIWELL and SKEAT). It hangs about all words relating to early modes of travelling, thus we have, "Pad," a stuffed saddle for carrying a pannier on horseback ; "Pad-nag," a road horse ; "Pad," a thief on the high road ; "Pad," Dutch, a path, "Pæth," Anglo-Saxon, a path ; "Pfad," German, a path, which latter English word is also itself cognate with pad ; "Pod," a bag carried on horseback ; "Pedlar," a travelling hawker. The word "Padlock" therefore means "Road lock," and it is significant in relation to the way in which padlocks of like form may have become distributed over wide areas in early times. The French word "Cadenas," a padlock, comes from the Latin "Catena," a chain, and the connection is obvious ; "Catenaccio," Italian ; "Candado" and "Cadena," Spanish ; "Cadenat," French provincial ; Berry "Chadaine," a cord ; Picard "Cagne" and "Caine;" hence also the French word "Chaîne," and the English "Chain."

We see from this, that, as is usual in like cases, the words have followed lines of

their own, and afford but little evidence of the forms of the objects to which they have been applied, excepting in so far that the common word "Klu" or "Clo" for lock and pin, and its connection with the base "Klu," to move, implies that the earliest form consisted of a movable bolt. But, in any case, whether we take the Latin word "Sero" to put, or the Sanskrit "Klu," to move, as independent origins of words for locks, we are carried back to a time when it consisted of a simple bar or bolt put up or slipped through staples to close a door. The passage in the 'Odyssey,' so often quoted in relation to the construction of Greek door locks, does not in reality throw much light upon the subject so long as it is unassisted by archæological discoveries. It has been variously translated,\* and we are left very much to conjecture for the forms of the most primitive kinds of locks which preceded those of which the relics are to be found in our collections of antiquities. It is noteworthy, however, that the earliest vestiges of apparatus connected with door fastenings in metal, that are discovered, consist of keys, which leads to the inference that the locks themselves may have been made of wood, and have therefore perished. But we have survivals of primitive wooden locks in use at the present time in different countries, which show us, with great probability, the uses to which the keys were put, and it is to these that we must turn in any attempt to trace back the history of the mechanism from the commencement. The process is one, the merits and demerits of which have been too often discussed to need comment here. In the absence of direct archæological evidence we have no alternative but to avail ourselves of survivals as far as possible. The materials, however, in the case of locks are so abundant that it will not be necessary to tax our imagination unduly in order to fill in the links that are found wanting.

Of the bar, whether of wood or iron, used for fastening up the door on the inside, little need be said, nor are we at a loss for a commencement in the common door bolt. Figs. 2 and 3, Plate I., represent the inside view and section of a wooden bolt now in use on barns and outhouses at Gastein, in Austria, and like many of the ordinary appliances which in most countries are now made of metal, it is there constructed entirely of wood, and is such a bolt as might have been used in the most primitive state of society. It is intended to open from the outside, where the handle, consisting of a flat oblong piece of wood (fig. 3, *a*, Plate I.), communicates, by means of a neck of wood, with the bolt *b* on the inside, and when shoved home to fasten the door,

\* 'Odyssey,' xxi., 46-50. See translations by POPE, and by BUTCHER and LANG. I put aside all mention of knots and strings which as Mr. SYER CUMING has observed ('Journal of the British Archæological Association,' vol. xii., p. 117) must have formed the fastenings employed by dwellers in tents, and of which the Gordian knot was a complicated example. In early times seals must often have served as substitutes for locks, as we know was frequently the case in ancient Egypt and Assyria. The wooden door must have given rise to a totally different contrivance. It is possible, however, that something analogous to the Japanese book fastening, represented in fig. 1, Plate I., may have been employed under both systems.

the neck moves along a slit in the door shown by the dotted line, fig. 2, *c c*, Plate I. Such a bolt can of course be opened by any one whether from within or without, and it has the further insecurity of being liable to be forced open accidentally by anything that might catch the handle, there being no fastening within to keep it securely in its place when shut. The simplest contrivance for remedying this latter defect would be to insert a peg or pin into the bolt, which might be left hanging by a string fastened to a staple when the door is open, and when bolted, inserted vertically into a hole in the top of the bolt in front of the upright guide or staple through which the bolt slides, as represented in figs. 4 and 5, Plate I., and it could be got at from without through a hole in the door. By this means the bolt would be kept securely in its place when shut, but it would require two motions both in opening and shutting the door.

Anything calculated to save time in a process of such ordinary occurrence as the opening and shutting of a door would be speedily adopted, and it would soon be found that by fixing the pin vertically in a slide, so as to fall freely, and making the lower end smooth, so as to slide along the upper surface of the bolt as the latter was drawn back, it might easily be so contrived that when shut it should fall by its own weight into the hole in the bolt, as represented in figs. 6, 7, 8, Plate I.; in the former of which it is shown open, and in fig. 7, shut, with the pin down in the hole, so as to secure it from being drawn back until the pin is raised, which might be done from the outside by means of a hole in the door, through which the string might be made to pass, as shown in the section, fig. 8. By this contrivance the bolt would only require one motion to shut it securely, and it might also be placed in the inside; but to open it again two motions would be necessary as before.

Still, however, the fastening would be accessible to everyone, and in a condition of society in which property must always have been insecure, it would become a great desideratum to construct a bolt which could be drawn back only by the use of a key, which the owner might carry about with him, and thereby secure his goods and chattels whilst he himself was absent in the fields, or in the hunting grounds. So necessary a requirement of every day life must have forced itself upon the notice of the greater part of mankind, and it is not surprising, therefore, to find that this stage of the development of the lock forms the point of trifurcation of three separate branches of improvement. Two of these are of the nature of tumbler locks, and consist of apparatus for raising the pin or pins by which the bolt is secured when they fall into the holes provided for them on the upper surface of it. It was for this reason that they were termed *tumblers*, because they tumble into the holes when the lock is closed. The third branch led off in another direction.

In order that the mind may not wander from the lines of continuity whilst I treat each of these three branches separately, I shall class them as A, B, and C in the diagrams, at the same time allowing the numbers of the figures to run on continuously from this point of departure. By this means I shall be best able to show the ramifica-

tions into which this mechanism, like all similar contrivances to which these papers relate, separate as they increase in complexity.

The common door bolt (figs. 2 and 3, Plate I.) having continued to be available as an inside fastening, in addition to more complex contrivances for securing doors, has continued to be universally employed up to the present time, and may be compared in nature to those fossil species, which, having never become unsuited to their environment, have survived throughout successive geological periods, whilst the forms represented in figs. 4 to 8, Plate I., being makeshifts, have disappeared as soon as they were superseded, and thus they constitute the "missing links" of our developmental series.

The two great desiderata in the stage of the lock that we are now considering were security and rapidity, both of which must have forced themselves on the notice of the primeval householder each time he crossed the threshold of his door. I shall begin with branch A in which security only appears to have been aimed at, and then proceed to those in which security and rapidity were combined. The first idea which suggested itself was to put a bolt in a box, so that no one could get at it to lift the tumbler without a key especially adapted to enter the box and raise it, but as long as only one tumbler was used it must have been very easy to pick such a lock by raising the tumbler with any sharp-pointed instrument that might be introduced into the hole. By using two tumblers, it would be impossible to raise them both at once, except by a key constructed with projections or teeth to fit into notches or holes in the tumblers, which teeth must necessarily be at the same distance apart as the notches, and as the tumblers were hidden in the box, no one unacquainted with the contrivance could make a key to fit the lock, which by this means afforded to some extent the security that was requisite.

Scandinavia appears to have been the headquarters of this class of locks, or at any rate the part of the world in which they have chiefly survived at the present time; one of the simplest of which is represented in figs. 9A, 10A, and 11A, Plate I., from the Faroe Islands. *e* is the wooden block into which is cut a horizontal groove for the bolt *a*, and two vertical grooves in which the pins or tumblers, *d d*, play, and when the bolt is shut to, they fall of their own accord into the holes *f f*. The key, *c*, is passed horizontally into another groove cut for it in the block, above and parallel to the one for the bolt. Two notches are cut in the tumblers to enable the key to pass, and when pressed in horizontally as far as it will go, the teeth of the key, *b b*, coincide exactly with the notches in the tumblers, so that when the key is afterwards raised vertically, it raises the tumblers, by means of the notches, out of the holes, *f f*, on the upper surface of the bolt, and the bolt can then be drawn out by the hand. It will be seen that this lock requires as many motions as the bolt (figs. 6, 7, and 8, Plate I.). It requires only one motion to shut it, when the two tumblers fall into the holes and keep it fast, but to open it, it is necessary to use both hands, one to raise the key and the other to draw out the bolt. It may therefore be termed for distinction a hand-drawn lock. No time is saved by this process, but the lock, for such we must now

begin to call it rather than bolt, is rendered more secure. Different kinds of these locks, but all on the same principle, are in use in out of the way parts of Scotland. Figs. 12A to 17A, Plate I., similar to the last but having a slight difference in the shape of the notches, is a Scotch wooden lock in the Patent Museum at South Kensington, a facsimile of which is in my collection. Figs. 18A to 22A, Plate II., is another, also in the Patent Museum, in which three tumblers instead of two are raised by the same key, as shown in the sections, figs. 21A and 22A, Plate II. Mr. ROMILLY ALLEN, who has written a paper on Scotch tumbler locks in the 2nd volume, New Series, of the 'Proceedings of the Society of Antiquaries of Scotland,' figures several others of the same class. One from North Ronaldsay has four tumblers in line; another from the Faroe Islands has three tumblers in line; another from Snizort, in Skye, has six tumblers working independently of each other but raised with the same key, and consists simply of two ordinary locks put face to face with the bolt between them; another from Harris is still more complicated in its construction, and is formed by five tumblers in line with two holes running through the whole of them, and the key has two limbs, one for each line of holes.

It is unnecessary for my present purpose to describe all these locks in detail. Though varying in character they are all constructed on one principle. As with the more complicated contrivances in metal, hereafter noticed, variety is an element of security, the greater the variety, the greater the difficulty of making a key which will fit them all; and this is another point in which the processes of the arts resemble the processes of nature, variety adapts the mechanism to a wider sphere of utility, and by encouraging change, promotes improvement. In the one, as in the other, variation is a necessary element of progress.

I see no reason to suppose that this class of locks was confined to Scotland or to Scandinavia. They may probably have existed in other parts of Europe, where, being made entirely of wood, they have long since decayed, and their representations may have survived only on the outskirts of civilisation. The law of geographical distribution is inexorable—nothing can make the North of Scotland or of Norway or the West of Ireland centres of the arts, and it is to such places we must look for the survival of primitive contrivances. A precisely similar key to those here described, but of iron, was found with Roman remains near Gloucester, and is figured in LYSONS'S 'Magna Britannia,' vol. ii., Plate 11, showing that a wooden lock of this kind must have been in use in England at that time. Figs. 23A to 25A, Plate II., is a similar lock used in Norway, and copied by me from a specimen in the Hazilius Museum at Stockholm.\* Figs. 26 to 28A, Plate II., is another in the Museum at Kew Gardens, copied by permission of Sir JOSEPH HOOKER; it was made by the negroes in Jamaica.

\* Mr. JOHN CHUBB in a paper read before the Institution of Civil Engineers, April 9, 1850, quotes a work by L. MOLINUS, "De Clavibus veterum," the date of which is, however, not mentioned, in which that author states that the use of keys was in his time still unknown in many parts of Sweden.

Figs. 29A to 31A, Plate II., is a similar one from British Guiana, in the CHRISTY Collection. One is tempted by the presence of these locks in the West Indies to suppose that they may have been carried by the negroes from their African homes, and the resemblance commonly attributed to them to the Egyptian wooden lock, constructed on nearly the same principle, might lead to the inference that they may have passed in that way to the West Indies; but it will be seen hereafter that they differ in detail from the Egyptian pin-locks. They are of the Scotch or Scandinavian type, and in all probability were imported into the New World by Scotchmen rather than negroes.

It is now necessary to return to figs. 6 and 7, Plate I., which represent the bolt with the single pin or tumbler, in order to trace the origin and development of Class B. Whilst in Scandinavia and the north of Europe, the key was applied to the upper part of the tumblers, above the bolt, as shown in the preceding examples of the hand-drawn lock; in Egypt, Asia, and probably in parts of Europe also, another system combining rapidity with security was introduced. A key with a single tooth was inserted beneath the bolt, and by raising the tooth vertically and applying it to the lower end of the tumbler, the latter was pressed out of the hole and raised clear of the bolt, and the tooth occupying its place in the hole, the key itself was made to hook back the bolt, so that the whole operation was performed with one hand holding the key. Fig. 9B, Plate II., represents this kind of lock, which may be termed a key-drawn, as distinct from a hand-drawn lock. As with the tumbler locks of the north of Europe so with the southern variety, security was obtained by multiplying the number of tumblers and varying their position. Figs. 10 to 12B, Plate II., are drawings of a wooden pin-lock and key obtained by myself in Egypt, which is of the kind habitually in use there at the present time. It has two tumblers in line. In fig. 10B the lock is represented with the key, A, in it and the tumblers raised, preparatory to drawing the bolt B. Fig. 11B is the key, and in fig. 12B the lock is shown shut, with the tumblers down and the key lowered preparatory to withdrawing it from the lock. Mr. ROMILLY ALLEN, in the paper already referred to, gives an illustration of one precisely similar which he obtained in Persia. Figs. 13B and 14B, Plate III., shows an exactly similar lock in the India Museum, obtained by Sir DOUGLAS FORSYTH at Yarkand, a facsimile of which is in my collection. This kind of lock is also used in Turkey; their identity throughout the region here spoken of is such as to leave no doubt of their having been copied from one another, and indicates the area of their distribution, about which something will be said further on.

It appears doubtful whether or not this pin-lock was known to the ancient Egyptians. RHIND\* states that he discovered one on a door in the interior of an ancient Egyptian tomb, but its date, from the description given in the text, appears doubtful. The tomb had certainly been opened in Roman times, if not later. DENON also says that he saw one sculptured in the Temple of Carnac, but he took no drawing of it,

\* 'Thebes, its Tombs and their Tenants,' by A. H. RHIND, F.S.A., London, 1862, p. 94.



and the evidence of the existence of this kind of lock in ancient Egyptian times certainly requires confirmation.\* Sir GARDNER WILKINSON is of opinion that the earliest example of a key with pins such as might be used with the pin-lock, is of the Roman period, in the reign of TRAJAN, A.D. 90, and the earliest known mention of any key at all is in the third chapter of Judges, viz., 1336 B.C.† If the pin-lock was in use in ancient Egypt it was certainly exceptional, as all the sculptures represent the doors as being fastened by simple bolts.

Whether the modern Egyptian lock is a survival of an ancient Egyptian form, or whether it is of Roman origin, it is certain, from the relics of Roman bronze and iron keys and bolts found in various parts of Europe, that the Roman lock was constructed on the same principle. Figs. 15B to 20B, Plate III., may be taken as illustrations of the Roman lock when put together. It is a reproduction from original fragments preserved in the Museum at Mainz. Fig. 20B is the bronze key; it has four teeth which, besides being at variable distances apart, are also of different forms, some being triangular and others square. Fig. 19B is the bronze bolt, made with apertures to fit the key, and also to admit of similarly formed tumblers, shown in fig. 18B. The way in which these are put together is represented in the section of the lock, figs. 16B and 17B. The key *a* is put into the keyhole *d*, fig. 15B, with the bar of the key containing the teeth in a vertical position, as represented by the dotted line *a*, fig. 16B. It is then turned round, and the teeth brought up beneath the bolt *b*. When pressed up vertically, the tumblers are driven up out of the bolt, and replaced by the teeth of the key, which hold the bolt so that it can be forced back by moving the key to the right. When the bolt is withdrawn, it releases the hasp *e*, fig. 15B. Of such hasps, fig. 21B is a drawing of an original in my collection, found at Hetternheim. By reference to fig. 16B, it will be seen that the tumblers, *ff*, are vertical, and would therefore fall into their places in the bolt, like those of the Egyptian and Scandinavian specimens; but being so small, and being probably made of wood, their weight would be insufficient to secure certainty of action, if dependent on weight alone; they are therefore pressed down by a flat plate *h*, figs. 16B and 17B, acting under the influence of a spring *g*, figs. 16B and 17B. This is an important addition, for it is evident that as soon as the spring comes into use, the tumblers can easily be made to press into the bolt horizontally, by means of a spring at the side, thereby enabling the lock to be used in any position in which it may be required; and there seems to be little doubt that some of the bolts and tumblers were so constructed in Roman locks. The existence of a spring in Roman locks is determined by the discovery of one with the spring in it, which is figured in M. LIGER'S work 'La Ferronnerie.'‡

\* Mr. BONOMI states that he found a similar lock in one of the Palaces at Khorsabad. The word used for lock in the Scriptures, 'Muftah,' he says is the same in use in the East at the present time. ('Nineveh and its Palaces,' by JOSEPH BONOMI, F.R.S.I.)

† WILKINSON'S 'Manners and Customs of the Ancient Egyptians,' vol. i., p. 355. The date of this passage in Judges is open to question. INMAN ('Ancient Faiths,' vol. ii., p. 193) puts the earliest introduction of locks amongst the Jews at about 300 B.C.

‡ 'La Ferronnerie, Ancienne et Moderne,' par F. LIGER, Paris, 1875, tome i., p. 266, fig. 213.

The teeth of the key of the Roman lock described above, it will be seen, are made to fit exactly the holes in the bolt; and this may perhaps have served to give the first idea of the ward system, which was so greatly depended upon for security in later times; but the same fallacy attaches to the use of these fitting teeth which attached to the ward system generally, for it is evident that any form of tooth small enough to go into the holes, and of the proper length, would have sufficed to lift the tumblers and draw the bolt; and accordingly we find that, in the Roman key usually discovered, the teeth are merely round pins, and have no particular form given to them for fitting purposes.

The distribution of this class of lock may be determined by the localities in which the keys and bolts have been found. Fig. 22B, Plate III., is a bronze bolt of this description in my collection, from Oppenheim, and obtained by me at Mayence. Fig. 23B, Plate III., is another of bronze, also in my collection, from Heddernheim. Similar ones have been found repeatedly in France, Italy, Germany, Switzerland, and England. The keys with teeth are even more widely distributed, and have been found in all those countries which have been occupied by the Romans. Fig. 24B, Plate III., is a large iron key of this description in my collection, found in the Rhine, at Mayence. The earliest known example of a key with teeth, according to M. LIGER, is one represented on a coin of the PAPIA family, dating about the end of the 2nd century B.C.\*

But the ward system appears to have developed itself still further in connection with these locks and before the revolving key was introduced. Fig. 25B, Plate III., is a specimen of a class of keys frequently discovered with Roman remains, in which a plate is attached at right angles to the pins. This plate is pierced with slits of various forms, apparently intended to admit of the passage of wards placed vertically beneath the bolt to prevent any but the proper key from rising to lift the tumblers. The direction in which these keys were raised is shown by the flat part of the handle of the key being always at right angles to the pins and in the same plane as the ward plate.

Besides the bolts with several tumbler holes in them, others adapted for single tumblers have been discovered. Of these fig. 26B, Plate III., drawn from M. LIGER's work, and found in the forest of Compiègne, is an example, and fig. 27B, Plate III., from the same work, and found at Nonfous, in Switzerland (Bonstetten.) is a key adapted to fit such a bolt.

Other iron keys are found in England and France, the application of which is more doubtful. They are found chiefly in connection with Celtic remains, and by some have been supposed to be keys for opening doors fastened with a simple latch on the inside.† Such latches were certainly employed amongst the earliest systems of door-fastenings, and the keys in question might have served the purpose of opening them, but they might also have been used to open locks with a single wooden tumbler; the simpler kinds resemble somewhat our modern pick-locks, of which fig. 28B, Plate III., is a specimen. Fig. 29B, Plate III., in my collection is from a Germano-Roman tomb

\* 'La Ferronnerie,' tome i., p. 261, fig. 208.

† Ibid., p. 320.

near Niderolm, and was obtained at Mayence; its possible use, in the manner represented in fig. 9B, Plate II., is obvious. Figs. 30B and 31B, Plate III., are two Anglo-Saxon keys found at Sarr, in Kent.\* Figs. 32B, 33B, Plate III., are two keys of the Iron Age from Bornholm, in the Baltic,†, attributed by M. VIDEL to the 3rd or 4th century of our era. Fig. 34B, Plate IV., is a somewhat similar one from Caerwent, in Wales.‡ It has a flat handle and appears to be adapted to be pressed downwards as if for opening a latch. Figs. 35B, 36B, Plate IV., are nearly similar ones, and were discovered in the Roman Villa at Hartlip, in Kent.§

Figs. 37B and 38B, Plate IV., are from drawings taken by me in the Musée de Saint Germain, and were found at St. Pierre-en-Chastre, Oise; others are figured in M. LIGER'S 'La Ferronnerie.'|| Fig. 39B, Plate IV., is in the British Museum, and was found within the entrenchments at Spettisbury, near Blandford; it was presented to the Museum by Mr. J. Y. AKERMAN. Figs. 40B and 41B, Plate IV., are two found by me in pits in the interior of Mount Caburn Camp, near Lewes.¶ Fig. 41B is of large size, 8 inches in length, and sickle-shaped. All the objects discovered in this camp proved it to be of the late Celtic period; the tin coins found associated with these remains, the bone combs, pottery, and other objects belong to an age anterior to the Roman conquest. Fig. 42B, Plate IV., is a similar one found by Mr. PARK HARRISON in similar pits in the neighbouring camp of Cissbury,\*\* in Sussex, which has been shown to have been occupied by people of the same age as Mount Caburn, viz. : the late Celtic period. It will be seen that some of these keys, all of which are of iron, have a small return or pin at the end, which is adapted to fit into a hole, and in the Cissbury specimen this end is flattened, as if to enable it to fit an aperture of special dimensions.

But for whatever purpose these crooked keys were used, whether as latch-keys, as keys for single-tumbler pins, or as hooks to pull back a plain iron or wooden bolt, the large size of some of them, especially that from Caburn, fig. 41B, and sickle shape, corresponds with remarkable accuracy to the description of a Greek key given by EUSTATHIUS, and quoted in PARKHURST'S 'Hebrew Lexicon.' He says that they were "in the shape of a sickle, and that not being easily carried in the hand on account of their inconvenient form they were carried on the shoulder, as we see our reapers carry on their shoulders at this day their sickles, joined and tied together." CALLIMACHUS, in his hymn to CERES, says that the goddess, having assumed the form of NICIPPE, her priests carried a key, *κατωμάδιος*, that is, fit to be borne on the shoulder.†† This

\* Paper by JOHN BRENT, Esq., in the fifth volume of 'Archæologia Cantiana,' p. 312.

† 'Mémoires de la Société Royale des Antiquaires du Nord,' 1872-77, Plate VIII., figs. 1 and 2.

‡ 'Isca Silurum,' by JOHN E. LEE, F.S.A., Plate XXXVI., fig. 1.

§ C. ROACH SMITH'S 'Collectanea Antiqua,' vol. ii., Plate VI., figs. 2 and 3, p. 20.

|| 'La Ferronnerie,' tome i., p. 320.

¶ 'Archæologia,' vol. xlvii., Plate XXIV., "Excavations in Mount Caburn, conducted by General PITT-RIVERS, F.R.S., in September and October, 1877, and July, 1878."

\*\* 'Journal of the Anthropological Institute,' vol. vii., p. 425, Plate XI., fig. 12.

†† This passage is quoted from a paper "On the Construction of Locks and Keys," read before the

also explains, I presume, the passage in Isaiah, "and the key of the House of DAVID will I lay upon his shoulder; so he shall open, and none shall shut; and he shall shut, and none shall open."\* It will be seen that the specimen found by me in Mount Caburn corresponds exactly with the description given in the above quotations, the curved portion of the key being  $7\frac{1}{4}$  inches in diameter, a bundle of them tied together would exactly fit the shoulder, as represented in fig. 43B, Plate IV. As we know from the researches of Mr. EVANS and others that imitations of the coins of Greece spread throughout Gaul and Britain, some of which, of very debased form and cast in tin, were found in the camp at Caburn in association with the sickle-shaped keys, and others have been found in connection with relics of the same period elsewhere, there is no inherent improbability in the supposition that the keys may have followed a like route.† Should further discoveries tend to confirm this connection, it would be a remarkable testimony to the value of archæological investigation if the well-known passage in the 'Odyssey' about the key of PENELOPE were to find its definite interpretation on the shores of Sussex.‡

We must now return to fig. 2, Plate I., in order to trace the third class, C, of locks and padlocks fastening with a spring catch. It seems probable that fixed locks may have preceded hanging ones, although, on the other hand, the want of some contrivance for securing property must have been felt in connection with saddle-bags, panniers, and other appliances of nomadic life, and in a condition of society which preceded the use of fixed abodes. Be this as it may, it seems possible to trace the employment of spring locks by means of survivals from the common door-bolt.

The origin of the spring padlock, in the present state of my knowledge on the subject, is doubtful. The sequence which I here assume is only tentative, and it is probable that connecting links with more primitive contrivances may be supplied hereafter. The defect of the common bolt, as I have already shown, was its insecurity as an outside fastening; in fact it afforded no security at all, and to remedy this defect and make it inaccessible, except by means of a key, several different contrivances appear from the first to have suggested themselves; amongst others, one of the simplest was adopted in connection with the Scandinavian bolt, a specimen of which, probably a modern survival of an ancient form, was exhibited in the Scandinavian

Institution of Civil Engineers by Mr. JOHN CHUBB, April 9, 1850, and is extracted from PARKHURST'S 'Hebrew Lexicon,' 5th edit., p. 600. London, 1807.

\* Isaiah xxii, 22. It has been suggested that this passage in Isaiah was introduced subsequently to the rest of the book, and dates from a period when keys came into general use amongst the Jews.

† Since the discovery that these objects were keys, I have reason to think that other things found in the same place and represented in the same plate, as for instance figs. 9 and 14, may have been door fastenings. 'Archæologia,' vol. xlvi., Plate XXIV.

‡ Mr. BONOMI gives an illustration of the way in which the modern Egyptian keys are carried by merchants at Cairo on the shoulder at the present time; these keys however are straight, and are hung to a stick over the shoulder, and are not sickle-shaped as described by EUSTATHIUS.

Section of the Exhibition of 1867, and is figured in M. LIGER'S work.\* We must suppose the handle in fig. 2, Plate I., and its neck connecting it with the bolt, to be removed, leaving only the slit in the door, along which the neck of the handle slid, and that a similar slit was made in the bolt also. The key, which was of iron, was T-shaped; it was inserted from the outside through the slit in the door, and in the bolt, with the arms of the T in a horizontal plane; it then received a quarter turn so that the arms of the T were brought into a vertical plane, and it was then pulled back, when the returns of the T were made to fit into two holes provided for them on either side of the slit in the bolt, on the inside, figs. 1c and 2c, Plate IV. By this means the key obtained a grip of the bolt, and it was only necessary to press it to one side in order to shoot it. This bolt, which is taken from M. LIGER'S work, so closely resembles the next one to be described, that if he had been a less careful writer one might suppose that it was the same lock, and that he had omitted to represent the spring which alone constitutes the improvement shown in figs. 3c, 4c, and 5c, Plate IV., which was presented to me by Dr. ENGELHARDT, at Copenhagen. It is still in use on barn and outhouse doors in Norway, and was first brought to notice by Professor O. RYGH, of Christiania. The key, which is of the same form as the last, enters the slit in the same manner, and after receiving the quarter turn is pressed home into the holes on the inside surface of the bolt like the last. In so doing, when firmly pulled back, it presses down a straight flat steel spring, the fixed end of which is attached to the door between it and the bolt, and the free end of which, when released, catches in a notch in the bolt so as to keep it securely in its place when shut. When the free end of this spring is pressed down by the returns of the key, it clears the edges of the notch, and the bolt can then be drawn back by pressing the key sideways. Both these specimens are therefore key-drawn as in Class B. Assuming this modern Norwegian lock to be a survival of an ancient form, one might naturally expect that the wooden portions of the ancient locks would have perished. The springs, which are the only metallic portions of this lock, would certainly become detached from the wood; their uses, when discovered separately, would not be recognised, and nothing to identify the mechanism with a door fastening would remain but the iron keys.

We must therefore judge of the distribution of this class of lock by the localities in which keys of this form are found. They are of two kinds, one T-shaped as in the preceding examples, and the other, serving the same purpose, but having the two teeth on one side of the shank; both are found together mainly in northern countries, which have been subject to Scandinavian influence. Notwithstanding which, however, the evidence is insufficient to establish the fact of their being of Scandinavian origin. They appear certainly to have been used in Roman times in England and elsewhere, and the influence of southern civilization upon the Scandinavian arts of the iron age is well established. It is always necessary to be on one's guard against inferring that forms originated of necessity in the regions in which they

\* 'La Ferronnerie,' tome ii., p. 229.

are most widely distributed, for, as we have seen, and have reason to believe, the wooden Scotch lock was carried to the West Indies and used by negroes on account of the facility with which it was constructed and the materials of which it was composed, so in all ages the more simple forms of contrivances must have found acceptance and survived longer on the outskirts of civilization than in those countries in which they were quickly superseded by new improvements.

Figs. 6c, and 7c, Plate IV., are iron keys of these two kinds obtained by me at Clermont-Ferrand, in Auvergne, France. Figs. 8c, and 9c, Plate IV., are two similar specimens from Colchester, which are figured in WRIGHT'S 'Uriconium,' where he supposes them to be latch keys, and he says that two similar ones were found at Wroxeter.\* Fig. 10c, Plate IV., another in my collection from Jordan Hill, near Weymouth. Fig. 11c, Plate IV., was discovered in a Roman building at Caudebec-les-Elbeuf, by the Abbé COCHET, in 1864,† together with an iron lock plate, fig. 12c, Plate IV., showing the slit through which the key entered, and which is similar to the modern Scandinavian specimen above described. Figs. 13c, and 14c, Plate IV., are two similar specimens discovered in a Roman villa at Hartlip, in Kent, and are taken from ROACH SMITH'S 'Collectanea.‡ Figs. 15c, 16c, and 17c, Plate IV., are similar keys found in Anglo-Saxon graves at Sarr, in Kent, where the presence of these keys on the left side of the skeleton usually denoted a female grave.§ A similar occurrence of keys in the graves of females has been noticed in the Island of Björkö. According to an old Scandinavian custom they were the badges of the lady of the house, who was said to be married to lock and keys, and from certain law texts of the Middle Ages, it appears that two of them were suspended from the girdle.|| Keys of this shape of both bronze and iron were found at Sarr, corroded together. It is worthy of remark that in these Saxon graves some fragments of Roman pottery were found, pointing to the influence of the earlier Roman period. Fig. 18c, Plate IV., is a bronze key from Gotland, and is taken from Mr. MONTELIUS'S 'Antiquités Suédoises,¶ where it is described as being of the late iron age, perhaps as late as the 10th century. Figs. 19c, and 20c, Plate IV., are from Björkö, in the Gulf of Bothnia, found in association with relics of the 8th century of our era.

Whether or not the lock which has been described in the preceding paragraph was the origin of the spring padlock, constructed entirely of metal, may perhaps be doubtful; but it is evident that the principle of its construction was the same. In both systems the bolt was secured by the end of a spring catch. It is only necessary to transfer the fixed end of the spring from the door to the bolt, and the notch from

\* 'Uriconium,' by T. WRIGHT, p. 270; see also 'Archæologia Cambrensis,' vol. vi., 1860, p. 312.

† 'La Seine Inférieure,' by M. L'Abbé COCHET, p. 223.

‡ 'Collectanea Antiqua,' vol. ii., Plate VII., figs. 2 and 4.

§ Paper by J. BRENT, 'Archæologia Cantiana,' vol. vi., p. 175, vol. vii., Plate XIII.

|| 'Scandinavian Arts,' by HANS HILDEBRAND, p. 129. Amongst the Romans also keys were regarded as the symbol of the wife's authority in her husband's household.

¶ 'Antiquités Suédoises,' p. 145.

the bolt to the door, to make it resemble the spring catch of the Roman padlock about to be described.

The Roman iron padlock and key represented in figs. 21c to 22c, Plate V., which is put together from specimens in my collection obtained partly from Jordan Hill, near Weymouth, and other sources, consisted of a square box, having a bar, *d*, on the top, and parallel to it, which was attached to one end of the box by means of a curved portion. The bolt *a* was provided with two perpendicular bars, *b b*, at the end of which were rings, *c c*, which slipped on to the parallel bar *d*. At the end of the bolt were two or more catch springs, *e*, put on like the barbs of an arrow. These, being placed into the hole of the tube *f*, at the same time that the rings were slipped along the bar, collapsed and sprung open again, after having passed the opening, thereby fixing the bolt in the tube. To open the lock, a pin or key, *g*, having a return at the end, in which was a slit made to fit the springs, was pressed in at the opposite end, so as to close up the springs, after which the bolt could be drawn out of the box. This action is better shown in the succeeding examples of modern spring locks of the same kind. The case of a similar padlock to the above was found with Roman remains at Ichester, near Wellingborough, Northampton, by the Rev. R. BAKER, in 1878, and is figured in the Associated Architectural Society's Reports, vol. xv., plate iv., 1879.

This padlock was therefore a hand-drawn, and not a key-drawn, lock. Its origin is at present uncertain, but it is here no doubt represented in its more complete and developed state, after having already undergone prior modifications. The absence of simpler contrivances of the same kind suggests the inference that its forerunners may have been made of perishable materials. Be that as it may, its progress onward from this point of perfection can be traced with some degree of certainty. Already in Roman times it had undergone changes. Amongst the Roman antiquities discovered in 1854 by the Honourable RICHARD NEVILLE (since Lord BRAYBROOKE), at Great Chesterford, in Essex,\* were two kinds of this padlock: one, represented in fig. 23c, Plate V., is of the form already described; the other (figs. 24c and 25c, Plate V.) was constructed on what, judging by those which succeeded it, must probably have been regarded as an improved form, or it may have been merely adapted to a different purpose. The bolt *a*, instead of having perpendicular bars and rings to slip over the parallel bar, was simply a plain straight bolt with the catch springs attached to it. The horizontal parallel bar of the lock, after passing along the top of the box or tube, was curved down over the mouth of the lock, at a short distance from it, and terminated in a ring, leaving a space between it and the mouth of the tube to admit of the passage of the chain or staple, or whatever was intended to be secured by means of the padlock, as shown in fig. 25c, Plate V. The bolt was slipped through this ring, and on into the tube, the barbed springs flying out and catching after they entered the box, so as to fill up this space and secure the bolt, which was opened and withdrawn in the same manner as before, as shown in fig. 24c, Plate V.

\* 'Archæological Journal,' vol. xiii., p. 7, Plate II., figs. 24 to 27.

A further modification of this takes place in the Swedish padlock, figs. 26c and 27c, Plate V., in which the parallel bar *d*, instead of being a fixture, is made to turn upon a hinge at *h*. When shut, the other end of the bar, instead of coming down over the mouth of the tube, and at a distance from it, as in the preceding example of a Roman padlock, is made to enter the side of the tube at *j*, and the bolt passes through the ring of the bar, after entering the mouth of the lock and inside, instead of outside of it. By this means we arrive at the ordinary hinge of the padlock which with further modification of form and mechanism is in use on carpet bags in this country at the present day. This Swedish spring padlock was in use in Scandinavia until towards the end of last century. There is one in the Museum at Kiel, which was found with iron spear-heads of the 11th century; others are attributed to the 15th century in that country. Figs. 31c and 32c, Plate V., is a specimen of an English fetterlock of the same construction as the Swedish one, obtained at Epping, near London, and we have evidence that a lock constructed on this principle continued in use throughout the Middle Ages. In 1829 a fragment of an iron padlock, consisting of the tube or box with its parallel bar attached to it, was found in association with some extended skeletons at Lagore, near Dunshaughlin, in the county of Meath, in Ireland. It is figured in the sixth volume of the 'Archæological Journal,' where it is described as an iron pipe, its use being apparently unknown to the writer. It was found in connection with iron leaf-shaped spear heads, broad double-edged swords, bronze pins, and enamelled ornaments, and the post-Roman period of the find is attested by the presence of the fallow deer amongst the associated animal remains. Figs. 28c, 29c, 30c, Plate V., is a Russian bronze padlock, believed to date between the 1st and 4th centuries, greatly resembling the Oriental ones to be hereafter described. It is in the Museum of St. Petersburg, and is copied from M. LIGER'S work. Fig. 33c, Plate V., is a fragment of one containing the springs and curved bar, found by me in excavations made in the Norman Camp at Folkestone. It was discovered in the body of the rampart, and in a position to prove that it was of the age of the construction of the camp, or of the period of its early occupation.\* Fig. 34c, Plate V., is a later example very much resembling the Russian padlock, fig. 29c, Plate V., and of the same kind as the last. The curved bar of the bolt fits into a socket in the parallel bar, in which respect it resembles some of the Indian ones to be hereafter described. It was found at Swanscombe, in Kent, and is probably of the 15th century. It is extracted from the 'Archæological Journal.†' Part of a padlock similar to this was lately found by Mr. JAMES WILSON in the ditch of Bedford Castle, and was exhibited at the Society of Antiquaries. Another similar one was found near Devizes, and is figured in Dean MEREWETHER'S 'Diary of a Dean,' fig. 18. Both of these last, like the Russian bronze one, represented in fig. 29c, are ornamented on the outside of the case with lines of zigzags, resembling Norman tracery; and coupled with the precise

\* 'Archæologia,' vol. xlvii.

† 'Archæological Journal,' vol. xxxi., 1874, p. 78.



resemblance in the construction of the locks, this ornamentation appears to prove an eastern connection during the first four centuries of our era. The fetterlock figures as the badge of the family of the LONGS of WRAXALL, dating from the 15th century, and it is at the present time the badge of the 14th Company of the Grenadier Guards, an illustration of which is given in the accompanying woodcut. It was one of the badges assumed by EDWARD IV., and an account of it is given in Sir F. HAMILTON'S history of that Regiment.\*



Badge of the 14th Company Grenadier Guards.

All the spring padlocks hitherto described have the defect of being in two parts; the bolt, being entirely detached from the tube when open, was liable to be lost, and to remedy this defect, modifications were introduced by which the bolt became a fixture in the tube and was opened by means of a key.

Fig. 35c, Plate V., is a lock which I found attached to one of my gates at Rushmore, in South Wilts. Externally, it exactly resembles the spring fetterlock, but within, the bolt which fixes the semicircular bar in its position when locked, is retained there by a spiral spring. To unlock it, a key with a female screw is put in at the end in the same position as the key of the Roman lock, and after seizing the male screw within, the bolt is screwed back against the spring, thereby releasing the semicircular bar or staple, which is then turned upon its hinge and drawn out of the opening on the side of the tube.

Fig. 36c, Plate V., is a precisely similar lock from Paris. Fig. 37c, Plate V., is another from Germany. Our modern handcuffs retain the form of the fetterlock, having the tubular case for the lock, which otherwise is not precisely the form most suitable to fit the human wrist. Fig. 38c, Plate V., is a section of an old handcuff obtained in Wiltshire, the bolt of which is forced out of the eye, not by means of a screw, but by a key of the ordinary form of a door key, inserted in the side of the tube, which when turned forces the bolt back against the spiral spring and releases the semicircular bar.

Whilst in some of the more modern contrivances the external form of the Roman spring padlock was retained, the interior mechanism having undergone changes, in others the interior mechanism is retained, the external form having adapted itself to the more modern uses. Figs. 39c, 40c, and 41c, Plate VI., is an old padlock which I obtained in Paris, the date of which I have been unable to determine, but a precisely similar one is attached to the iron chest of the Royal Society, which was

\* 'History of the Grenadier Guards,' by Lieut.-General Sir F. HAMILTON, K.C.B., vol. i., p. 61.

presented to the Society in the year 1665, and for the knowledge of which I am indebted to Dr. JOHN EVANS, F.R.S., the Treasurer of the Society. Externally it resembles the modern padlock, but both ends of the semicircular staple are provided with springs on the principle of the Roman padlock. It is opened by means of a revolving key of modern form, which is inserted into the side of the padlock, and which, when given a quarter turn presses back the three springs upon the bolts, and the staple is then withdrawn bodily from the body of the lock. In this case, the staple, being quite separate from the lock, would be liable to be lost, as with the spring of the Roman padlock; so to remedy this defect we see in figs. 42c and 43c, Plate VI., obtained at Clermont-Ferrand, in Auvergne, an improvement in which one of the arms of the staple passes down through the padlock and out at the bottom of it, where it terminates in a button, intended to prevent its being drawn entirely out and separated from the lock. The other arm is furnished with a spring as in the last example and, like it, is opened by a revolving key. When the spring is pressed back it is drawn out and merely turned upon its longer arm as a pivot.

Up to this point I have endeavoured to trace the gradual development of the European padlock from the earliest contrivance of Roman times up to the present time. In order to show its distribution and the varieties it has undergone in other parts of the world we must now return to the spring padlock in its earliest form. Figs. 44c, 45c, and 46c, Plate VI., represents an iron padlock from the Gate of Moulton, in India, now in the India Museum. It is in all respects similar to the Roman lock shown in figs. 21c to 23c, Plate V., and needs no further description. Figs. 47c and 48c, Plate VI., is a padlock obtained by me of a vendor of old iron in the streets of Cairo in 1881. It is constructed on precisely the same principle as the last, and is opened by a key thrust in longitudinally at the end of the tube, like the Roman key, but the opposite end of the bolt instead of being guided by a ring slipping along the parallel bar of the lock is curved round and inserted into a tube or socket in the parallel bar, like the Russian specimen and that from Swanscombe, in Kent. Figs. 49c and 50c, Plate VI., is another specimen obtained by me at Cairo; it also resembles the Roman lock in its construction, except that the key instead of being thrust in at the end of the tube is put in underneath at right angles to the tube, and having enclosed the springs by means of an opening cut in the side of the key, in order to compress them, it is thrust sideways along the tube, the neck being guided by a slit along the bottom of the tube. Figs. 51c and 52c, Plate VI., shows another specimen in my possession from India, which so precisely resembles the last that one is tempted to suppose they must both have been made in the same place, were it not for certain peculiarities which identify it as Indian. The key in closing on the springs is guided by two slits along the bottom of the tube instead of one, and beneath the tube is a projecting piece in the form of a Greek cross which fits into corresponding slits in the key so that none but the proper key can pass by it to compress the springs. This contrivance is therefore of the nature of a ward. Figs. 53c, 54c, and 55c, Plate VI., is another from India, now in the India Museum,

the locality of which, viz., Myhere, is attached to it. Figs. 56c and 57c, Plate VI., is an Egyptian manacle in my collection fastened in the same manner. Figs. 58c, 59c, and 60c, Plate VII., is a similar lock from Abyssinia, now in the British Museum, affording additional evidence that the key, with the lateral movement inserted at right angles to the lock, is African as well as Indian. Two padlocks precisely similar to this are in my collection from Mogadore, on the West Coast of Africa, having on them the peculiar Moorish ornamentation in brass which is characteristic of that country.

We have now to go to China for evidence of the continued distribution eastwards of this particular kind of spring padlock with the lateral key. Figs. 61c, 62c, and 63c, Plate VII., is a brass Chinese padlock and key in my collection. To the north of India we have figs. 64c, 65c, 66c, 67c, Plate VII., representing a padlock from Yarkand obtained by Sir DOUGLAS FORSYTH, and now in the India Museum. It has also the key with the lateral action. Mr. THOMAS WRIGHT says that he possesses a similar padlock, given him by the British Vice-Consul at Jacmel, and obtained from Hayti, which he says was probably a century old, and either made in one of the Spanish colonies or imported from Spain.\* Sir GARDNER WILKINSON also mentions one from Meroe Island, in Egypt,† and Mr. H. SYER CUMING speaks of one as having been obtained in Western Africa, but the locality is not stated.‡

In order to show the modifications that this lock has undergone during its eastern migrations, I have represented (figs. 68c, 69c, and 70c, Plate VII.) a steel lock from Indore, India. It is furnished with a staple with two arms like the European specimen, fig. 39c, Plate VI., one of which only has springs attached to it; it is now in the India Museum. Figs. 71c, 72c, 73c, 74c, Plate VII.—also in the India Museum: the bolt with its springs is attached to plates forming an outside casing to one side of the lock, by which means the opening is concealed, and the opening for the key is also concealed in a casing for the other side, and opens also with a catch spring released by the pressure of a straight pin or wire introduced through a hole beneath the lock. Figs. 75c, 76c, and 77c, Plate VIII., is another variety, from Burmah; the key is introduced at the end of the tube by means of a male screw, formed somewhat like the propeller of a screw steamship. This screw is merely for the purpose of introducing the key into the tube by a half-twist; once in, it is pressed straight forward, and compresses the springs in the usual manner. Fig. 78c, Plate VIII., is the opening and key of a similar lock obtained by me in Nuremberg. It is constructed precisely on the same principle as the last, and with a similar object; it has all the appearance of being European, but I have no certain evidence that it may not have been imported from India. In figs. 79c, 80c, and 81c, Plate VIII., from Indore, India, we see the screw

\* 'Excavations at Wroxeter and Uriconium,' by T. WRIGHT, F.S.A., p. 273.

† 'Caillaud, Voyage à Meroe,' Plate LXVI., Sir G. WILKINSON, vol. i., p. 355.

‡ "History of Keys," by H. SYER CUMING, Esq., 'Journ. British Archæological Association,' vol. xii., p. 117. The keys of this description mentioned in the paper as having been found at Thebes are in all probability modern, judging by their entire resemblance to modern forms.

principle developed. Whether this originated in a lock of the last-mentioned form—and the screw, from having at first been used as a ward, was ultimately employed to release the bolt by a screw motion—I know not; but it exactly resembles in its construction the lock shown in fig. 35c, Plate V., from the gate at Rushmore, Wilts, and those of like form from France and Germany already figured and described. The bolt is retained in its place when locked by a spiral spring, and withdrawn by a screw key inserted at the end. Whether this is an independent growth in the two hemispheres, or copied the one from the other, I have no present means of determining. Unfortunately, when the objects in the India Museum at South Kensington were transferred from the old India Museum their history was lost; but I have figured none except those which have the localities attached to them. Figs. 82c, 83c, and 84c, Plate VIII., is a steel lock from India of similar external form to fig. 71c, Plate VII.; but the screw principle appears here to have entirely superseded the spring, which is altogether wanting, and it is dependent for its action entirely on a screw key inserted at the end, and by means of which the bolt (which itself formed the staple) is screwed up or screwed back again as required. As a parallel to this, the specimen in my collection represented in figs. 85c, 86c, 87c, 88c, and 89c, Plate VIII., may be given. It was obtained by me in Brussels, and resembles the tubular lock only in external form. The staple is secured to the tube at each end by eyes let into the side of the tube, through which a pin is passed, and screwed up or unscrewed by a key put in at the end of the tube. When unscrewed the pin is withdrawn and the staple taken out bodily. In this, as in the Indian specimen last described, the original spring mechanism has entirely disappeared; but, although resembling each other in this respect, there is nothing analogous in the two systems, which, from differences in the details of their construction, appear to be quite independent contrivances. Figs. 90c, 91c, and 92c, Plate VIII., represent a padlock and key from Toomkoor, Mysore, India. It is a barbed spring padlock of the ordinary kind, but the springs are closed preparatory to being withdrawn by means of a common revolving key inserted in the side and having a broad slit in the middle of the revolving plate. By giving the key a quarter-turn the slit in the key-plate compresses the springs, and they are then withdrawn from the lock. The action of the key in this specimen resembles exactly that of the padlock from Paris (fig. 39c, Plate VI.) and that of the Royal Society chest, except that in the Paris and Royal Society specimens two springs are compressed by means of a solid plate, whilst in the Toomkoor example a single-barbed spring is compressed by the action of a slit in the key. Barbed tubular spring locks of precisely the same form as the Chinese ones are also used in Japan, of which figs. 93c, 94c, 95c, and 96c, Plate IX., represent a specimen in my collection. Of these, some of the keys entered at the end of the tube; others are put in at the side, as shown in fig. 97c, Plate IX. The key, which, like the lock, is of brass, is placed in a handle, which shuts up like the handle of a knife (as shown in fig. 96c, Plate IX.) for convenience of transport. Another specimen from Japan (represented in figs. 98c and 99c, Plate IX.) resembles exactly the

Toomkoo specimen from India, the springs being compressed by means of a revolving key. This must certainly be regarded as the first stage of improvement upon the original Roman lock, and its employment in Europe, India, and Japan is noteworthy.

Amongst the specimens of these tubular spring locks, which appear to show evidence of connection over wide areas, are those which are constructed in the forms of animals. Figs. 100c and 101c, Plate IX., is a representation of a bronze padlock in the form of a fish, now in the Louvre, at Paris, figured by M. LIGER. It is there described, though not without hesitation, as an Egyptian lock; if so, it is probably of the Romano-Egyptian period: the springs enter at the mouth of the fish, and are released by a key put in at the tail. Figs. 102c, 103c, 104c, Plate IX., represents a precisely similar fish-shaped padlock of iron from India, and now in the India Museum. Figs. 105c and 106c, Plate IX., is a Roman bronze lock in the form of a lion or horse, in the possession of Dr. JOHN EVANS, F.R.S., and here copied by his permission; a similar one is in the British Museum. Figs. 107c, 108c, and 109c, Plate IX., is another, also in the form of a lion, and about the same size, from China, in the collection of Mr. CHUBB, the well-known locksmith. In all these the springs enter at the stern of the animal, and the other end of the bolt turns up and back in the form of a tail, and enters the neck of the animal behind the head. The key in the Chinese specimen has a peculiar secret contrivance to prevent its being inserted in the hole for it by anyone not acquainted with its construction. The head of the key will not enter the keyhole unless the handle end is put in first and slipped along the shank of the key, as represented in the drawing, fig. 109c, Plate IX. Mr. ROMILLY ALLEN, whose work on Scotch wooden tumbler locks I have already quoted, refers incidentally in his paper to spring locks, and says that he has himself seen them used in Persia in the forms of animals. We are thus led to infer that the practice of making them in these forms may have existed, or may still exist, continuously throughout the region referred to, and that, like the mechanism itself, and like many other articles of commerce, they may have passed by traffic from place to place, and been copied and adopted in the localities in which they are found. Fig. 110c, Plate IX., is a padlock obtained by me at Cairo; similar ones are in common use on out-houses at Naples, the long bar at the top denoting its descent from the Roman padlock, although the construction of the lock is different.

We now come to the principle of the revolving key in common use at the present time. It has been already shown that in using the Roman lock (figs. 15B to 20B, Plate III.) the part of the key containing the pins had to be put in vertically, and then turned a quarter circle, so as to bring the teeth horizontally beneath the tumblers previously to lifting them. It is possible that this may have suggested the first idea of employing the twist thus given to the key to the shooting of the bolt. Fig. 111, Plate IX., taken from M. LIGER's work,\* represents a Roman key found in London; it has a plate furnished with teeth, evidently intended to raise tumblers, and

\* 'La Ferronnerie,' tome ii., p. 236, fig. 492.

the stem of the key is piped for the purpose of fitting into a broach or pin, so that the plate with the teeth, when the key is turned round on its pivot, may fit into its proper place beneath the bolt and raise up the tumblers. Fig. 112, Plate IX., is a drawing of another key similarly formed, having two teeth and a piped stem; it was found in Lothbury, in London, 16 feet beneath the surface, and is figured in Mr. SYER CUMING'S paper on keys in the 'Journal of the Archæological Association.'\* These keys appear hardly to admit of any doubt as to their mode of use, and may therefore be regarded as the earliest specimen of revolving keys, although applied to a different purpose from the revolving key of our own time. The most primitive kind of lock with a revolving key that I have met with is one represented in figs. 113, 114, 115, 116, Plate X. It is from India, and is in the India Museum. The key is applied to a square vertical tumbler of the Scandinavian type with two arms to fit into two notches in the bolt; the lower end of the tumbler terminates behind the bolt, in a semicircular form; the key, when turned upon its broach or pin, as the case may be, impinges upon the sides of the semicircular portion and raises the tumbler out of the notches on the top of the bolt, and afterwards the end of the key-plate passes into one of a series of notches on the under side of the bolt and moves it, whilst the tumbler is, at the same time, raised clear of the bolt. The key being turned several times continues the movement, pushing the key forward notch after notch, until the tumbler again falls into other holes provided for it, and keeps the bolt secure. All here is of wood, except the key, which is of metal, and it is provided with slits to pass the wards, adjusted to them in the revolution of the key-plate upon its pivot. It might be supposed from this that it was a modern adaptation to an ancient system of vertical tumblers, had not a very similar, but simpler, lock existed in China. The drawing (figs. 117, 118, 119, 120, 121, Plate X.) of a Chinese lock was kindly sent me by Mr. ROMILLY ALLEN. In this specimen the bolt is shot in nearly the same manner as the last specimen, but the tumblers are raised independently by means of a T-shaped key (fig. 121, Plate X.), similar to that used with the Scandinavian lock (fig. 3C, Plate IV.). The key from the outside is put into the vertical slit between the tumblers, when it is turned a quarter circle so as to bring the arms of the T in a horizontal plane. It is then pressed back, when the returns of the T enter notches provided for them in the tumblers. The tumblers are then raised, and the key or handle, *a*, turned. From the inside the tumblers are raised with the two fingers before shooting the bolt.

M. LIGER supposes that the lifting key of the Roman lock was of Asiatic origin, and that the revolving key came into use amongst the Romans about the commencement of our era, and many of the keys from Pompeii are constructed on this principle having slits for the passage of wards. Fig. 122, Plate X., is a Roman key of this kind in my collection. The ward system came into general use afterwards and

\* 'Journal of the Archæological Association,' vol. xii., p. 121, Plate XIV., fig. 1.

† 'La Ferronnerie,' tome i., p. 264.

was much relied upon to the exclusion of others in the Middle Ages. The ward system may be defined as a system of lock in which obstructions are placed to prevent any but the proper key from entering to turn the bolt; as such it is distinct from the tumbler system, in which security depends on obstruction introduced to prevent the bolt from being drawn by the key. The tumbler is, in fact, a bolt of a bolt. Reference to fig. 10B, Plate II., representing the Egyptian lock, will show that besides the two pins with which the key is provided for lifting the tumblers, there is a pin attached to the under side of the lock opening, which enters a hole in the key. This is of the nature of a ward, since none but a key with a hole in the proper place could be raised up high enough to lift the tumblers clear of the holes in the bolt. Mr. ROMILLY ALLEN also mentions that in one of the Scotch locks from Snizort, a notch is placed in the key and a corresponding pin in the lock, to prevent the lock from being picked, and that the key-hole is divided by a thin iron plate which is the only thing approaching a ward that appears in any of the wooden locks of Scotland. The peculiar shape of the tumblers and tumbler-holes in the bolts of the Roman lock, already described, with teeth made especially to fit them, must be regarded as a kind of ward, although applied to tumblers, since their object is to prevent any but the proper form of key from entering.

The further development of the ward-system in the Roman tumbler-locks, though it certainly existed, is involved in uncertainty, since none of the wards appear to have been preserved, but the fact of some kind of ward having been used is evident from the slits in the keys represented in fig. 122, Plate X., which are of common occurrence. The cross-shaped wards beneath the Indian spring padlock already described in connection with figs. 53C, 54C, and 55C, Plate VI., must certainly be considered to be wards, although open to view, and not concealed beneath the lock-plate. There are also found in association with Roman remains, keys of which fig. 123, Plate X., from Chalons, fig. 124, Plate X., from the Museum at Saumar, and fig. 125, Plate X., from the Museum at Saint Germain, are examples.\* These keys so greatly resemble the Asiatic keys used with the spring padlock, that it is difficult to believe they were not employed in the same way, but as they also resemble the Roman perforated plates of the tumbler-lock keys that are provided with teeth, it is probable they may have been intended for raising tumblers in some way not yet explained. No tubular spring lock adapted to be opened with a key inserted underneath, and opened with a lateral movement like the Indian and Egyptian ones, has to my knowledge been found amongst Roman remains. Fig. 126, Plate X., is a modern English latch-key of similar form, furnished with a ward-plate and used for raising a common latch: they are now generally disused, from being unsafe. With the revolving keys resembling the modern form, found at Pompeii and elsewhere, slits for fixed wards are common, and show that the Roman keys of the commencement of the present era resembled our own. During the Middle Ages reliance was placed almost entirely on the ward system, and

\* 'La Ferronnerie,' tome ii., Plate LV., E, G, K., p. 238.

many complicated contrivances were introduced, of which fig. 127, Plate X., is a specimen, until the close of the last century, when their insecurity led to the re-introduction of tumbler-locks.

It is not known exactly when this took place, but probably at some time during the 18th century, and possibly earlier. This time, the tumblers instead of being vertical (as was the case during what may be called the early tumbler period) were horizontal, resting on a pivot above the bolt and kept down by a spring. Figs. 128, 129, and 130, Plate X., is a tumbler lock in the possession of Mr. CHUBB, found whilst repairing an old house at Funtley, Hants, said to be 200 years old. If so it must be regarded as the earliest specimen of the second tumbler period. The tumbler moves on a pivot, and is kept down by a spring, the revolving key raises the tumbler by pressing up the curved bar attached to it, which raises the stud of the tumbler out of the notch provided for it on the upper side of the bolt, thereby freeing the bolt, so that by further turning the key it is enabled to shoot the bolt. The tumbler, it will be seen, cannot be raised too high. If the plate of the key is long enough to raise the stud of the tumbler out of the notch, a key with a longer plate will answer the same purpose. To remedy this defect and necessitate the employment of a key of exactly the proper size, Mr. BARRON, about the year 1778, introduced an improvement known by his name, represented in fig. 131, Plate X., in which the bolt is provided with a slit along the middle just wide enough to allow the stud to pass; the slit has notches both above and below, so that if the stud is raised too high by a key with too long a plate it is forced into the upper notch and the bolt continues immovable. He also introduced two tumblers requiring to be raised to different heights in order to coincide with the slit in the bolt by means of different projections on the edge of the key plate, so that the bolt could only be shot by means of a key with a plate expressly constructed to fit the lock, and having two projections of the requisite length. This principle of employing two or more tumblers is the one on which nearly all subsequent improvements have been effected. Those who desire to prosecute the subject further will find a variety of modern tumbler locks in my collection introduced during the latter half of the last and commencement of the present century. They are all, in the main, varieties of one principle, terminating in the CHUBB and HOBBS locks of the present time. As this paper relates only to primitive locks I do propose to describe them here. The continuity which pervades all the ramifications of the modern lock is not less complete than in the earlier forms, and would well bear treating in the same manner as those which I have described. The Bramah lock, though in external appearance differing from the others, is no less based upon the earlier forms, and may be described as a union between the *ward* and the *tumbler* systems. It is a ward system, because the obstructions introduced into the mechanism are intended to prevent the turning of the key to shoot the bolt by any but a key of the proper construction. It is a tumbler system because the impediments so placed upon the turning of the key are in fact tumblers packed round the cylinder of the key (retained



by springs), and allowing the passage of the key-plate only when pressed down to the various depths to which each separate tumbler is adapted in order to provide an open passage for the key-plate all round. This union of ideas developed separately in different branches of the same trade, device or industry, corresponds to the crossing of individuals and breeds in nature, which is so necessary to reproduction. The analogy, as I have already intimated elsewhere, might be carried even further and closer if space permitted. It is a necessary condition of the absence of creative power in nature, and applies equally to all the processes of evolution whether of species or of ideas, but the subject requires broader treatment than can be given to it here. My object in writing this paper being to trace the development of particular forms rather than to generalise, I must leave the philosophy of the subject for separate treatment.

From the foregoing description of the various kinds of primitive locks in use in different countries it will, I think, have been made evident that some of them most certainly have been derived from a common centre. The wooden key-drawn pin-locks have spread over the region extending from Egypt to Yarkand. The Scandinavian wooden locks of the same kind, though differing in the details of their construction, we have seen are common to Norway and Scotland, and by some means have been carried to the West Indies and British Guiana, whilst the tubular spring padlock of the Roman age in Europe is the same that is found throughout the whole region extending from Italy to China and Japan on the east, northward into England and Scandinavia, southward into Abyssinia, and westward into West Africa and Algeria, Spain, and on as far as the West Indies.

It is sometimes thought when simple contrivances such as weapons of stone and bronze, some of the simpler kinds of ornaments, and of tools obviously adapted to primeval life are found to extend over wide areas, and in places very remote from one another, that the few ideas necessary for the construction and use of them might easily have suggested themselves independently in different places. To the student of primitive culture who has become impressed with the persistency of art forms, this independent origin of such things does not appear so certain even in the case of the most simple contrivances. But when we come to a complex piece of mechanism, such as a spring padlock having several parts—the spring, the case, the parallel bar, and the key, in all of which the resemblance is maintained in distant countries, and which, with slight modification and continuously progressive improvements, are put together in the same manner in all parts of the world—such a supposition cannot be admitted, the necessity for a common origin is apparent, and the study of the periods and the circumstances connected with the distribution of it cannot be set aside as superfluous.

Assuming that the tumbler pin-lock and the spring padlock cannot be traced back earlier in Europe than the commencement of our era, it is by no means certain that they may not have existed earlier elsewhere. The commerce carried on with the East in early times was of a nature to render it very probable that any contrivance for

securing goods should have spread from place to place with the merchandise exported and imported between China, India, and Europe. A brief survey of the trade relations between different countries will be sufficient to show this.

The expedition of ALEXANDER gave rise to intercourse which was kept up by the Greek kingdom of Bactria, and recent Indian discoveries both of coins and sculptures prove more and more the great influence which Greek art exercised in India up to the commencement of our era. STRABO says that, about B.C. 22, NICOLAUS DAMASCENUS fell in with three Indian ambassadors at Antioch Epidaphne on their way to the Court of AUGUSTUS, and that their credentials were in the Greek language. DIODORUS quoting IAMBULUS speaks of King PALIBOTHA in the early part of the 1st century as a lover of the Greeks. DIO CHRYSOSTOM mentions that the poems of HOMER were sung by the Indians, and ÆLIAN says that not only the Indians but the kings of Persia translated and sang them. If the travels of APOLLONIUS and DAMIS are to be credited, the Greek language was spoken in the Punjaub in the first half-century of our era, and frequent intercourse appears to have taken place between that country and Egypt.\* PLINY in the 1st century A.D. says, on the authority of VARRO, that under the direction of POMPEY it was ascertained that it took seven days to go from India to the River Icarus, believed to be the modern Roscha, in the country of the Bactri, which discharges itself into the Oxus, and that the merchandise of India being conveyed from it through the Caspian Sea into the Cyrus, might be brought by land to Phasis in Pontus in five days at most.† The best steel used in Rome was imported from China.‡ ARRIAN, in the 2nd century A.D., speaks of a frequented way, λεωφόρος ὁδός, extending in the direction of India through Bactria; after which four embassies from the East are noticed by ancient writers, one to TRAJAN, A.D. 107; another to ANTONINUS PIUS, A.D. 138-161; a third to JULIAN, A.D. 361; and the fourth to JUSTINIAN, A.D. 530. These are but scant memorials of an intercourse which must have been frequent between India and Rome, and which reached its highest development during the reigns of SEVERUS and CARACALLA, in the commencement of the 3rd century A.D.

Turning now to the southern route of communication with India, PLINY describes Taprobane (Ceylon), and mentions an embassy sent from thence to the Emperor CLAUDIUS. The discovery of the monsoons during the 1st century was the means of creating a great trade between India and Alexandria. STRABO says that in the time of the PTOLEMIES some 20 ships only ventured upon the Indian seas, but that this traffic had so greatly increased that he himself saw at Myos Hormos, on the Arabian Gulf, 120 ships destined for India. PLINY gives in detail the route from Alexandria to India in his time, and says that it was well worthy of notice because in each year

\* 'The Indian Travels of Apollonius of Tyana,' by OSMOND DE BEAUVOIR PRIAULX.

† PLINY, Book vi., chap. 19.

‡ 'Ancient Bronze Implements,' by JOHN EVANS, D.C.L., &c., p. 19; PLINY'S 'Nat. History,' Book xxxiv., chap. 41.

India drained the empire of at least 550 sesterii, estimated at £1,400,000 of English money, giving back in exchange her own wares, which were sold at fully one hundred times their original cost, and he says that the voyage was made every year by the following route:—Two miles distant from Alexandria was the town of Juliopolis, supposed to be Nicopolis. The distance from thence to Coptos up the Nile was 308 miles, and the voyage was performed with a favourable wind in 12 days. From Coptos the journey was made on camels to Berenice, a seaport on the southern frontier of Egypt, 257 miles, in another 12 days. Here the passengers generally set sail at midsummer, and in about 30 days arrived at Ocelis, in Arabia, now called Gehla, or at Cane, supposed to be Cava Canim Bay. From hence, if the wind called hippaulus happened to be blowing, it was possible to arrive at Muzitis, the modern Mangalore, which was the nearest point in India, in 40 days. This, however, was not a convenient port for disembarking, and Barace was therefore preferred. To this place pepper was carried down in dug-out canoes made out of a single trunk from Cottonara, supposed to be Cochin or Travancore. The return voyage was usually made in January, taking advantage of the south-east monsoon, by which means they were able to go and return the same year. But when PLINY wrote, the trade with India was only in its infancy, afterwards Greek factories were probably established at the Indian seaboard, which accounts for the Greek names for some of the towns on that coast.

But the people of Alexandria having become insolent in their prosperity, HADRIAN was led to encourage the route through Palmyra, which was the most direct road to India. Even in the 2nd century A.D. the trade between Rome and India through Palmyra must have been considerable, for it drew the attention of the Chinese. Their annals speak of it as carried on principally by sea; they mention Roman merchants in relations of commerce with and visiting Burmah, Tonquin, and Cochin China, and they have preserved the memory of an embassy from the Roman emperor, which in the year A.D. 166 was received by the Chinese sovereign. Arab or native vessels appear to have brought the produce of India up the Persian Gulf to the mouth of the Euphrates. At Teredon they discharged their cargoes, and the merchandise was then carried to Vologesia by camels; at this place the merchants of Palmyra took it up and it was here exchanged for the produce of Europe. Even as late as the 5th century, ships from India and China are mentioned lying at Hira on the Euphrates, a little to the south of Babylon. Through the influence of this trade Palmyra grew rapidly into wealth and power until the widow of GALBERIUS threw off her allegiance to Rome. This led to the destruction of the city by AURELIAN, A.D. 275, which put an end to the Roman trade with India through the Persian Gulf. The Alexandrian trade with India fell off about the same time, and the barbarians occupied Coptos, the port of embarkation for India, about A.D. 279.

After the fall of Palmyra the Indian trade was transferred to Batne, near the Euphrates, but it lasted only a short time, and in the 4th and 5th centuries may be

regarded-as having become extinct in so far as Roman merchants were concerned. The trade, however, was still kept up by the Arabs. EPIPHANIUS, about A.D. 375, gives an account of trade carried on through Berenice, by which the merchants of India imported their goods into the Roman territory, and there is also Chinese authority for believing that a great trade between Rome and India existed in the 6th century. MA-TOUAN-LIN, A.D. 1317, in his researches into antiquity, affirms that in A.D. 500-516 India carried on a considerable commerce by sea with Ta-Tsin, the Roman Empire, and with the Ansi the Syrians,\* but Arab and not Roman vessels were employed. MASOUDI says that in the early part of the 7th century the Indian and Chinese trade with Babylon was principally in the hands of the Indians and Chinese. The usual passage after rounding the Point de Galle was to creep up the Madras coast during the S.W. monsoon and take a point of departure from Masulapatam towards the leading opening of the Ganges.† Meanwhile the overland trade between Europe and India in the 3rd and 4th centuries was carried on by the Sassanidæ, who in the 4th century entered into commercial relations with China, to which country they sent frequent embassies in the 6th century, and through this route silk was imported into Europe. In A.D. 712 Sind was conquered by the Arabs, and in addition to the kingdom of Mansurah and Multan, other independent Muslim governments were established at Bania and Kasdar.‡ There is also the evidence of the merchant SULAMIN and the researches of Mr. EDWARD THOMAS into the coins of the Balhara to prove the continuance of Arab intercourse with India during the 9th century.

During all this time the relations between Scandinavia and Rome appear to have been scarcely less extensive. Although the Romans never succeeded in penetrating Scandinavia, the discovery of coins, vases in bronze and glass, and other objects of art, is sufficient to prove that Scandinavian art was greatly influenced by intercourse with Rome during the first part of the 2nd century of our era. In the early stages of society, communication by sea offered greater facilities for traffic than land journeys, and for this reason the Island of Gotland, now so isolated and rarely visited except by antiquaries, appears to have served as a portal for the entry of Roman and Oriental goods and civilization into Scandinavia.§ After the fall of the Roman empire, Scandinavia was left to its own resources, aided by occasional intercourse with Byzantium, until in the later iron age, extending from the 8th century to the middle of the 11th century, another line of communication was established with the East, still entering Scandinavia mainly through the Island of Gotland. Mr. HILDEBRAND records the discovery of 20,000 Arab coins in Sweden and Gotland, and traces the

\* PRIAULX, p. 244.

† "The Indian Balhara and Arabian intercourse with India in the Ninth and Following Centuries," by E. THOMAS, F.R.S., 'Numismata Orientalia,' vol. iii., 1882.

‡ "Coins of the Arabs in Sind," by E. THOMAS, F.R.S., in the 'Indian Antiquary.'

§ 'La Suède Préhistorique,' by O. MONTELIUS.

channel of their transmission by Russian finds from the states near the Caspian, through Russia to the shores of the Baltic, and thence, thanks to the commerce established by the inhabitants of Gotland, over to that island. From Gotland, and probably also by direct intercourse with Russia, the Mahomedan coins were spread over Scandinavia, being more common in the eastern provinces of Sweden than in the west or in Norway. The greater part of these coins appear to have come into Sweden between the years 880 and 955, but the latest belongs to the year 1010. On the line of communication here indicated, iron keys of the kind adapted both to the tumbler lock and the spring padlock have been discovered in the governments of Vladimir and Jaroslav, in the graves of the Neriens,\* dating about the 8th century A.D., showing that in all probability it was by this line that the use of these locks were imported into Sweden. The key of the padlock found here was of the form of the Roman key, (fig. 21c, Plate V.), the Indian one (fig. 46c, Plate VI.), and the modern one from Cairo (fig. 47c, Plate VI.). It also resembles that of the Swedish lock (fig. 26c, Plate V.), and belongs to the most primitive form of the mechanism.

Whilst this traffic was being carried on between Scandinavia and the East, the intercourse of the Vikings was kept up with Britain, Ireland, and the coasts of the English Channel, commencing in 787 and continuing to the 11th century. These Western relations, like those with the East, appear to have taken place chiefly through Gotland; and the number of Anglo-Saxon coins found in that Island and the East of Sweden greatly exceed those discovered in Norway and the West.

The foregoing summary of the evidence of commercial relations between Southern Europe and the East and North during the early part of the Christian Era is sufficient to show that ample facilities existed for the spread of early forms of locks and keys. The padlock, more especially—which, as I have said when referring to the etymology of the word “pad,” was the class of lock associated with portable merchandise—must have been carried into all those parts of the world between which commercial relations had been established.

At what time and through what particular channels the various kinds of locks were distributed can only be determined after more extended inquiry into the archæology of padlocks. Some points may, however, I think be considered to be more or less established by the evidence I have adduced. The particular form of padlock represented in fig. 44c, Plate VI., from India, and fig. 21c, Plate V., from the Roman period of Europe, must in all probability have been communicated in Roman times, as I am not aware that this precise form of padlock was in use in Europe later than the Roman age, having been superseded by the more modern improvements which have been described in this paper. The use of padlocks in the forms of animals in Egypt, Persia, and China, must also very probably belong to the same period. The Chinese and Japanese padlocks appear to belong to a more advanced stage of the development of the mechanism, and correspond to the form used in Europe in the Middle Ages; whilst

\* “Antiquités du Nord Finno-Ougrien,” par J. R. ASPÉLIN, ‘Age du Fer,’ iii., figs. 977, 980, 981.

the use of the revolving key in Europe, India, and Japan to compress the springs, as shown in figs. 39c, Plate VI., 90c, Plate VIII., and 98c, Plate XI., must date from a still later phase in the art; and unless they are to be regarded as improvements introduced independently in those countries, the idea must have spread by means of Arab traders, if not still more recently. In like manner, the adoption of the screw principle with these locks must either have been conveyed by traders, or applied independently in different countries to the form of padlock already in use. The hinge of the staple, as seen in figs. 26c and 31c, Plate V., though derived from the earlier form of the parallel bar, which has a wide distribution, has not been universally adopted, but is used chiefly in Sweden and Europe, and is an improvement introduced, no doubt, in modern times. Further information is needed to enable us to trace the distribution of all these different varieties more continuously, before any satisfactory judgment can be formed as to the date of connection. In Scandinavia we find the padlock in use in Gotland, in Björkö, and in Sweden; and HANS HILDEBRAND, in his work on 'The Industrial Arts of Scandinavia,'\* published by the South Kensington Museum, says that they were already known in that region in Pagan times. It is to be hoped that this announcement may be only a prelude to some more detailed publication of his researches into a subject to which the present paper can only be regarded as a first introduction—not previously attempted, that I am aware of, in its ethnological and commercial bearings. Local archæologists must work out the rest. Enough has, I trust, been said to show that a large field lies open to the student of the archæology of locks and keys, and that whenever the history of this mechanism is traced in Scandinavia, Persia, India, and China, in the same way that I have endeavoured to trace it in Europe, much light will thereby be thrown on the ramifications of trade and the commercial relations of distant countries in non-historic times.

\* 'The Industrial Arts of Scandinavia,' by HANS HILDEBRAND, 1883.

*On the Development and Distribution of Primitive Locks and Keys.*

PLATE I.

- Fig. 1. Japanese book fastening derived from the common pin.
- Figs. 2 and 3. Common wooden bolt used at Gastein, in Austria, at the present time.
- Fig. 2. Front view.
- Fig. 3. Transverse section on A B.  
*a.* Handle. *b.* Bolt. *c c.* Slit for handle, *a.*
- Figs. 4 and 5. Wooden bolt with pin fastening (supposed form).
- Fig. 4. Front view.
- Fig. 5. Transverse section on A B.
- Figs. 6 to 8. Wooden single tumbler bolt (supposed form).
- Fig. 6. Front view (open).
- Fig. 7. Front view (closed).
- Fig. 8. Transverse section on A B.
- Figs. 9A to 11A. Wooden double tumbler lock from the Faroe Islands.
- Fig. 9A. Front view.
- Fig. 10A. Longitudinal section.
- Fig. 11A. Transverse section.  
*a.* Bolt. *b b.* Teeth of key, *c.* *d d.* Tumblers. *e e e.* Block.  
*f f.* Holes in bolt.
- Figs. 12A to 17A. Old Scottish wooden tumbler lock (Patent Museum).
- Fig. 12A. Front view.
- Fig. 13A. Side view.
- Fig. 14A. Longitudinal section.
- Fig. 15A. Transverse section.
- Fig. 16A. Section through A B.
- Fig. 17A. Section through C D.

FIG. 1.

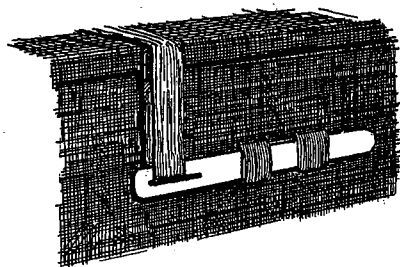

FIG. 2.

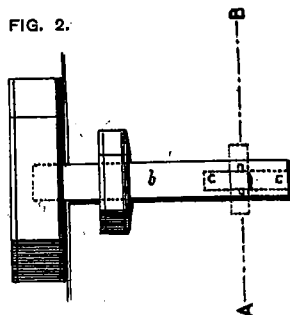

FIG. 3.

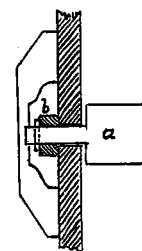

FIG. 4.

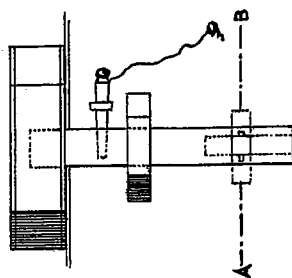

FIG. 5.

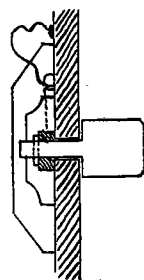

FIG. 6.

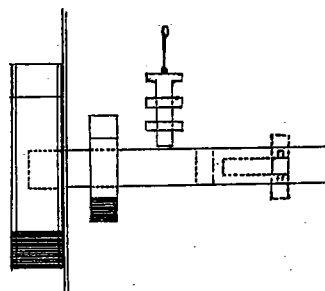

FIG. 7.

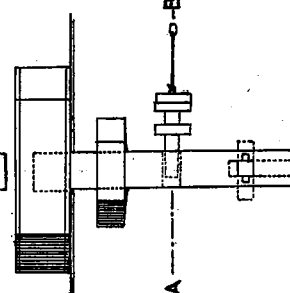

FIG. 8.



FIG. 9A.

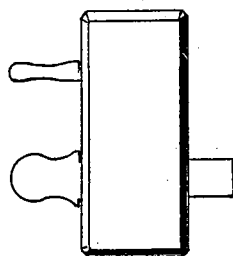

FIG. 10A.

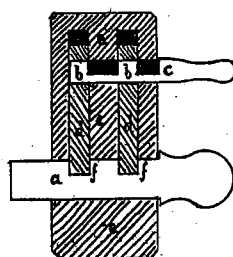

FIG. 11A.



FIG. 12A.

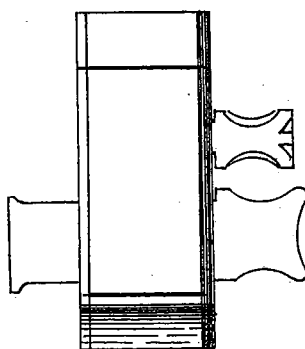

FIG. 13A.



FIG. 14A.

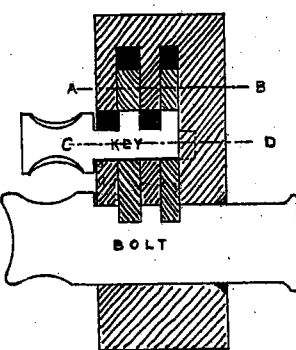

FIG. 15A.

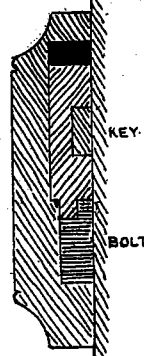

FIG. 16A.



FIG. 17A.





*On the Development and Distribution of Primitive Locks and Keys.*

PLATE II.

Figs. 18A to 22A. Old Scottish treble wooden tumbler lock (Patent Museum).

Fig. 18A. Front view.

Fig. 19A. Side view.

Fig. 20A. Longitudinal section.

Fig. 21A. Transverse section.

Fig. 22A. Section through A B (fig. 21A).

Figs. 23A to 25A. Wooden tumbler lock from Norway (Hazilius Museum, Stockholm).

Fig. 23A. Front view.

Fig. 24A. Longitudinal section.

Fig. 25A. Transverse section on A B.

Figs. 26A to 28A. Wooden tumbler lock made by negroes of Jamaica (Museum, Kew Gardens).

Fig. 26A. Front view.

Fig. 27A. Longitudinal section.

Fig. 28A. Transverse section on A B.

Figs. 29A to 31A. Wooden tumbler lock from British Guiana (CHRISTY Collection).

Fig. 29A. Front view.

Fig. 30A. Longitudinal section.

Fig. 31A. Transverse section.

Fig. 9B. Probable use of fig. 29B, Plate III., as a key for a single tumbler lock.

Figs. 10B to 12B. Modern Egyptian wooden tumbler or pin-lock in use at the present time.

Fig. 10B. Longitudinal section showing pegs raised by key A preparatory to withdrawing the bolt B.

Fig. 11B. Key A.

Fig. 12B. Longitudinal section showing pegs down and bolt locked.

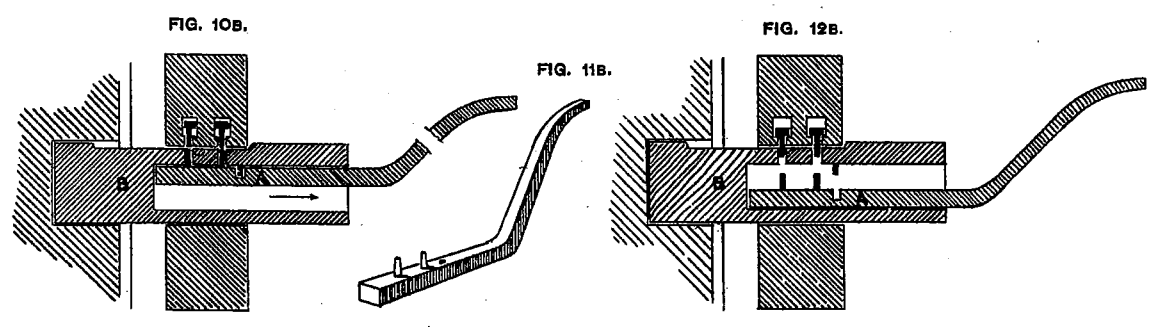
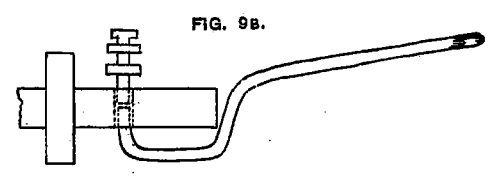
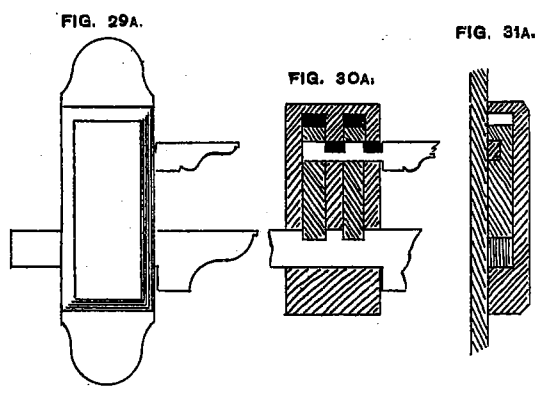
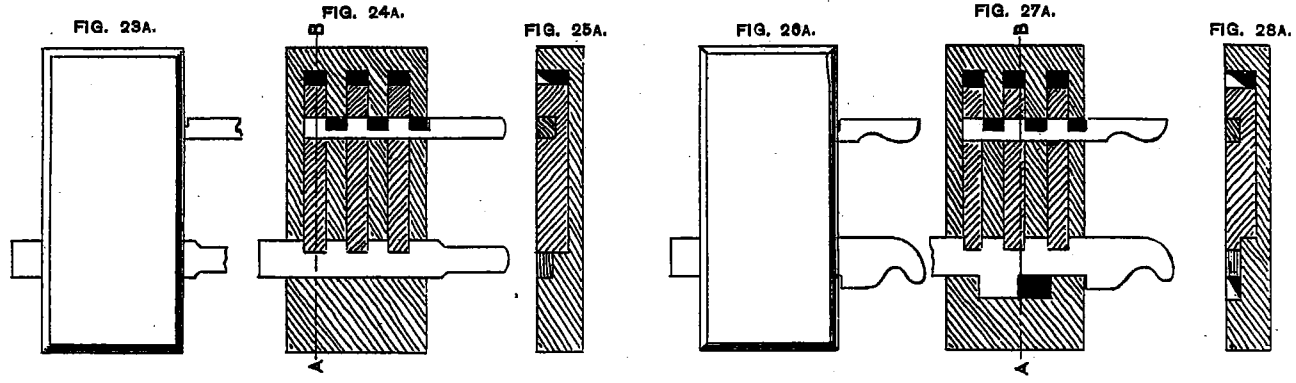
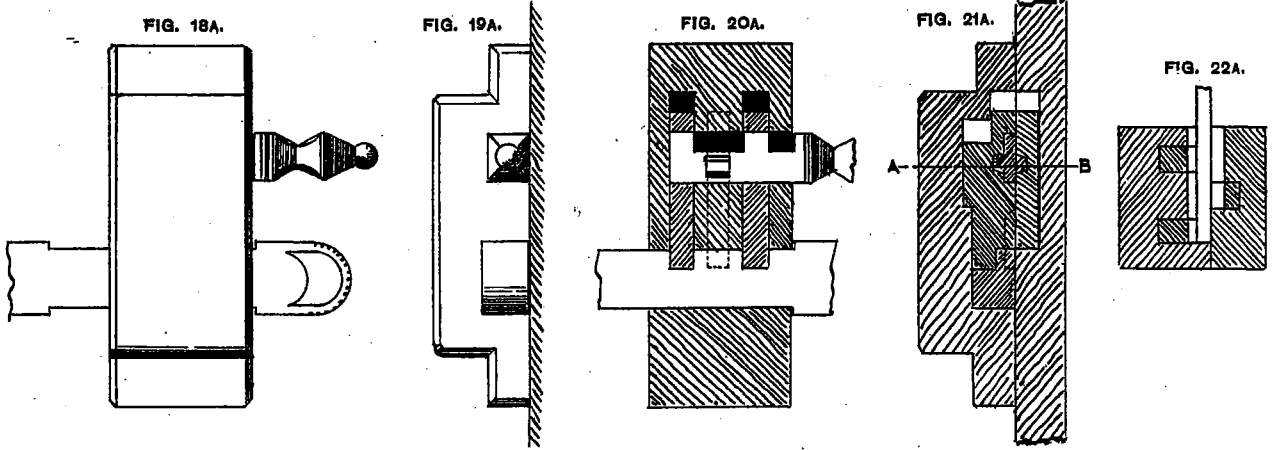

*On the Development and Distribution of Primitive Locks and Keys.*

PLATE III.

- Figs. 13B and 14B. Modern wooden tumbler or pin-lock from Yarkand (India Museum).
- Fig. 13B. Longitudinal section showing pegs raised by key A preparatory to withdrawing the bolt B.
- Fig. 14B. Longitudinal section showing pegs down and bolt locked.
- Figs. 15B to 20B. Reproduction of Roman tumbler lock (Mainz Museum) (Lindenschmit).
- Fig. 15B. Front view.
- Fig. 16B. Longitudinal section.
- Fig. 17B. Transverse section on C D.
- Fig. 18B. Section through A B.
- Fig. 19B. Bolt (top view).
- Fig. 20B. Key.
- a. Key. b. Bolt. c. Block. e. Hasp. ff. Tumblers. g. Spring.  
h. Plate of spring.
- Fig. 21B. Ancient hasp from Hetternheim, Roman.
- Fig. 22B. Bronze bolt from Oppenheim, Roman.
- Fig. 23B. Bronze bolt from Heddernheim, Roman.
- Fig. 24B. Iron key found in the River Rhine at Mayence, Roman.
- Fig. 25B. Key for tumbler lock with ward plate, Roman ('La Ferronnerie').
- Fig. 26B. Bolt for single tumbler found in the Forest of Compiègne, Roman ('La Ferronnerie').
- Fig. 27B. Key to raise single tumbler lock found at Nonfous, Switzerland, Roman ('La Ferronnerie').
- Fig. 28B. Modern pick-lock.
- Fig. 29B. Key found in Germano-Roman tomb at Niderolm (probable use shown in fig. 9B, Plate II.).
- Fig. 30B. }  
Fig. 31B. } Two Anglo-Saxon keys found at Sarr, in Kent ('Archæologia Cantiana').
- Fig. 32B. }  
Fig. 33B. } Two keys from Bornholm, in the Baltic ('Mémoires de la Société Royale des Antiquaires du Nord').

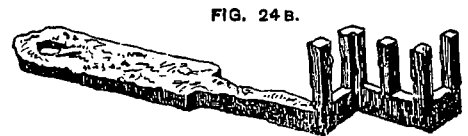
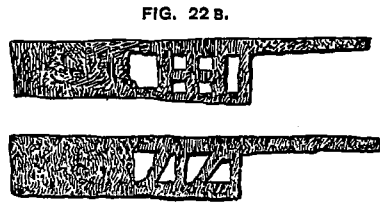
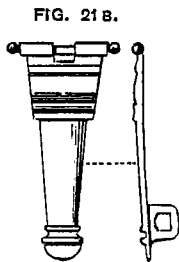
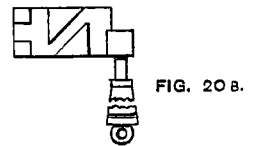
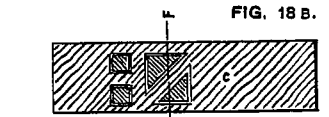
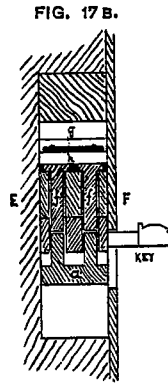
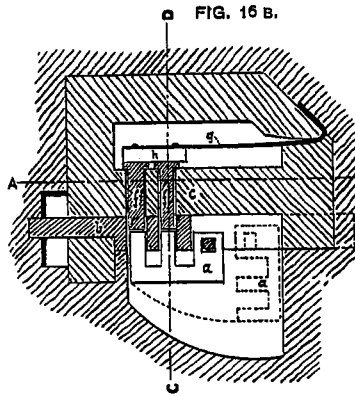
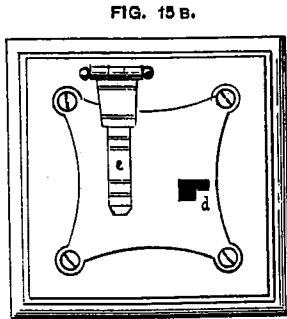
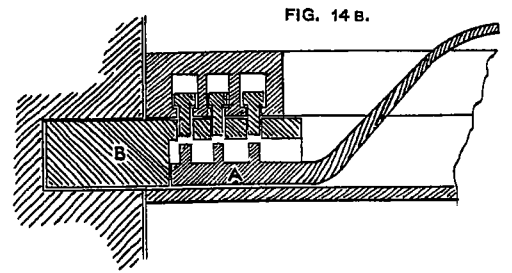
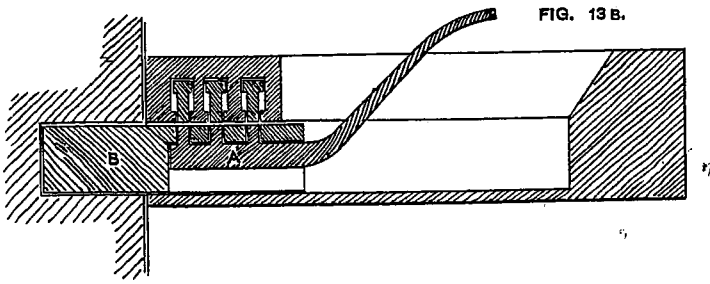
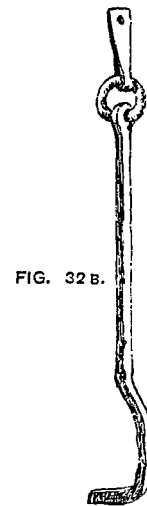
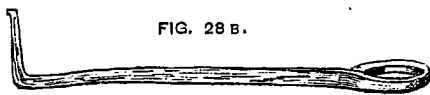
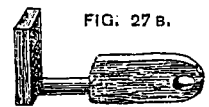
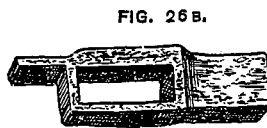
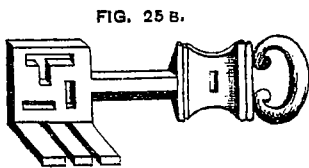

FIG. 23 B.



*On the Development and Distribution of Primitive Locks and Keys.*

PLATE IV.

- Fig. 34B. Key found at Caerwent, in Wales ("Isca Silurum").
- Fig. 35B. } Two keys found in Roman villa at Hartlip, Kent ('Collectanea  
Fig. 36B. } Antiqua').
- Fig. 37B. } Two keys found at St. Pierre-en-Chastre, Oise. Gaulish. From drawings  
Fig. 38B. } taken by Gen. PITT-RIVERS, in the Musée de Saint Germain.
- Fig. 39B. Key found at Spettisbury, near Blandford. British. (British Museum.)
- Fig. 40B. } Two keys found in Mount Caburn Camp, near Lewes, by the Author.  
Fig. 41B. } British. ('Archæologia.')
- Fig. 42B. Key found in Cissbury Camp, Sussex. British. ('Journal Anthropological  
Institute.')
- Fig. 43B. Represents the ancient mode of carrying keys on shoulder, adapted to the  
British key found in Caburn. (Fig. 41B.)
- Figs. 1c and 2c. Modern Scandinavian bolt and key ('La Ferronnerie').  
Fig. 1c. Front view.  
Fig. 2c. Transverse section on A B.
- Figs. 3c to 5c. Modern Scandinavian bolt and key, with spring A. From a model  
presented by Dr. ENGELHARDT, and used in Norway.  
Fig. 3c. Longitudinal section.  
Fig. 4c. Transverse section.  
Fig. 5c. View showing keyhole.
- Fig. 6c. }  
Fig. 7c. } Two iron keys from Clermont-Ferrand, Auvergne, France.
- Fig. 8c. }  
Fig. 9c. } Two iron keys from Colchester, Essex, ("Uriconium").
- Fig. 10c. Iron key from Jordan Hill, near Weymouth.
- Fig. 11c. Iron key from Caudebec-lès Elbeuf ('La Ferronnerie').
- Fig. 12c. Iron lock-plate found with above (fig. 11c).
- Fig. 13c. } Two iron keys from Roman villa, at Hartlip, Kent ('Collectanea  
Fig. 14c. } Antiqua').
- Fig. 15c. }  
Fig. 16c. } Three keys from Anglo-Saxon graves at Sarr, Kent ('Archæologia  
Fig. 17c. } Cantiana').
- Fig. 18c. Bronze key from Gotland, Iron Age ('Antiquités Suédoises').
- Fig. 19c. }  
Fig. 20c. } Two keys from Björkö, in the Gulf of Bothnia, 8th or 9th Century A.D.

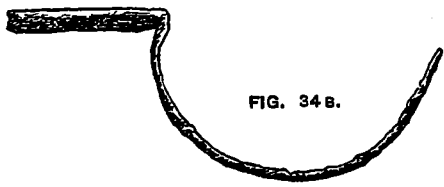

FIG. 34 B.

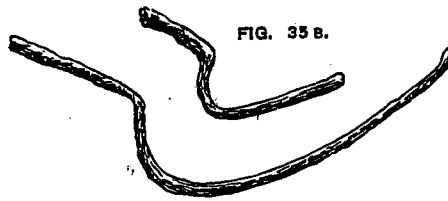

FIG. 35 B.

FIG. 36 B.

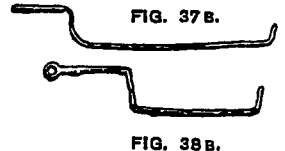

FIG. 37 B.

FIG. 38 B.

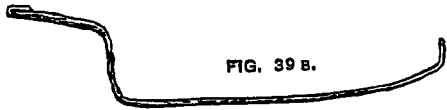

FIG. 39 B.

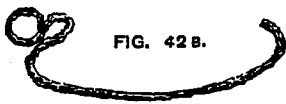

FIG. 42 B.



FIG. 43 B.

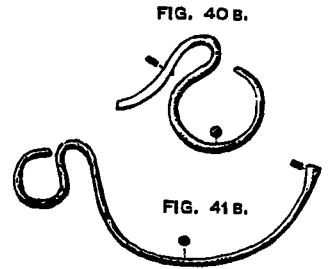

FIG. 40 B.

FIG. 41 B.

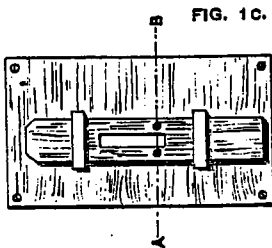

FIG. 1 C.

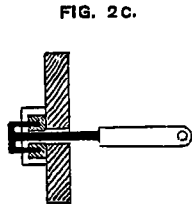

FIG. 2 C.

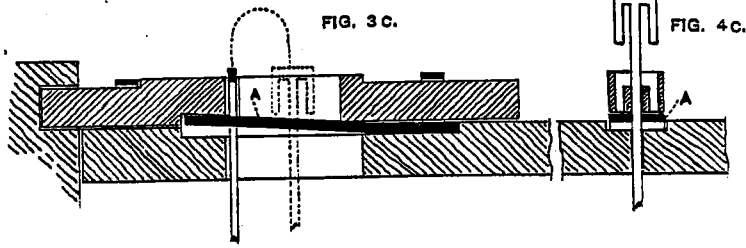

FIG. 3 C.

FIG. 4 C.

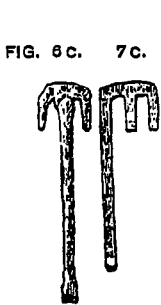

FIG. 6 C.

7 C.

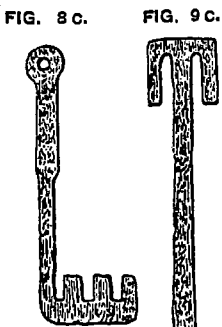

FIG. 8 C.

FIG. 9 C.



FIG. 10 C.

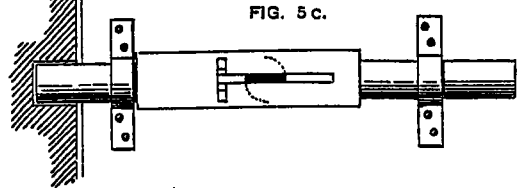

FIG. 5 C.



FIG. 11 C.



FIG. 12 C.

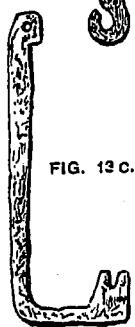

FIG. 13 C.



FIG. 14 C.



FIG. 15 C.



FIG. 16 C.



FIG. 17 C.

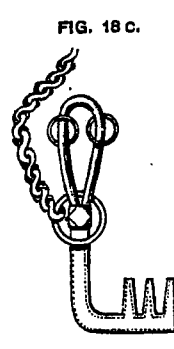

FIG. 18 C.



FIG. 19 C.

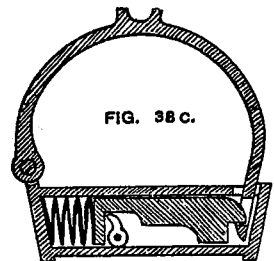
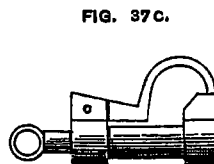
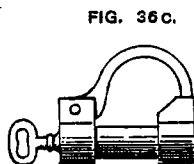
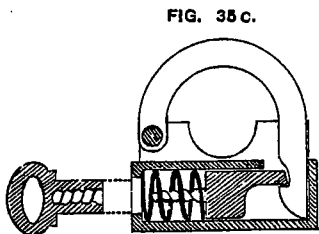
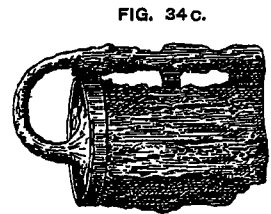
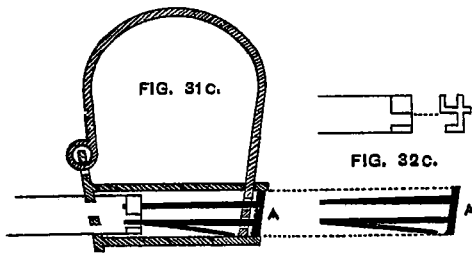
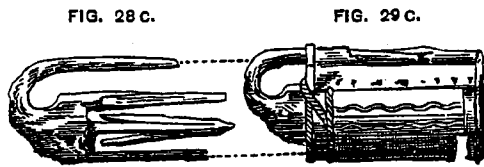
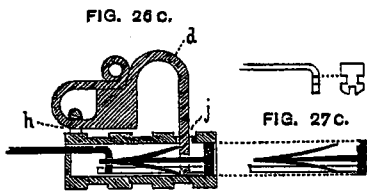
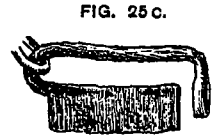
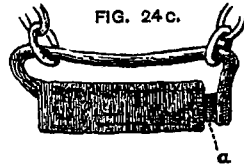
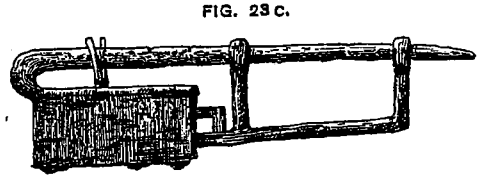
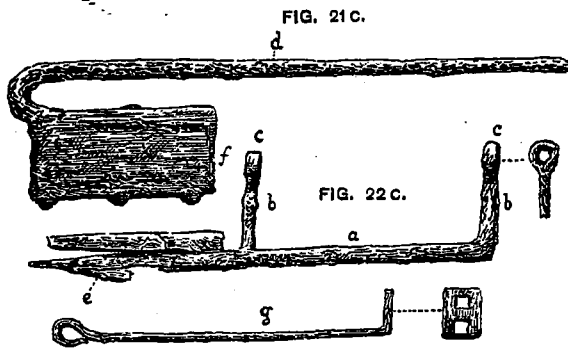

FIG. 20 C.

*On the Development and Distribution of Primitive Locks and Keys.*

PLATE V.

- Figs. 21c and 22c. Portions of Roman padlock found at Jordan Hill, Weymouth.  
Fig. 21c. Side view of lock-case and parallel bar.  
Fig. 22c. Side view of bolt with spring catch. *a*. Bolt. *b b*. Perpendicular bars of bolt. *c c*. Rings to slip over parallel bar *d*. *e*. Catch springs. *f*. Hole in tube through which bolt is passed. *g*. Key.
- Figs. 23c to 25c. Roman padlocks found at Great Chesterford, Essex ('Archæological Journal').  
Fig. 23c. Side view of supposed original form.  
Fig. 24c. Improved form, showing bolt, *a*.  
Fig. 25c. Improved form without bolt.
- Figs. 26c and 27c. Old Swedish padlock.  
Fig. 26c. Longitudinal section.  
Fig. 27c. Side view of bolt and springs. *d*. Parallel bar turning on hinge at *h*, and entering tube case at *j*.
- Figs. 28c to 30c. Old Russian bronze padlock, St. Petersburg ('La Ferronnerie').  
Fig. 28c. Side view of bolt and springs.  
Fig. 29c. Side view of tube case.  
Fig. 30c. End of case showing aperture for springs.
- Figs. 31c and 32c. Old English fetterlock, from Epping, near London.  
Fig. 31c. Longitudinal section.  
Fig. 32c. Side view of bolt and springs A. Side and end views of key shown above.
- Fig. 33c. Fragment of bolt with springs, found in rampart in excavations at the Norman Camp, Folkestone ('Archæologia').
- Fig. 34c. Iron padlock found at Swanscombe, Kent, 15th Century ('Archæological Journal').
- Fig. 35c. Longitudinal section (with key) of modern padlock, from Rushmore, Wiltshire, spiral spring action.
- Fig. 36c. Side view of modern padlock, from Paris, spiral spring action.
- Fig. 37c. Side view of modern padlock, from Germany, with spiral spring action.
- Fig. 38c. Longitudinal section of modern handcuff, from Wiltshire, with spiral spring action, unlocked by a revolving key.





*On the Development and Distribution of Primitive Locks and Keys.*

PLATE VI.

- Figs. 39c to 41c. Padlock, from Paris, probably 17th Century, spring lock, unlocked by a revolving key.
- Fig. 39c. Front view.
  - Fig. 40c. Transverse section.
  - Fig. 41c. Longitudinal section.
- Figs. 42c and 43c. Old iron padlock from Clermont-Ferrand, France.
- Fig. 42c. Front view.
  - Fig. 43c. Side view.
- Figs. 44c to 46c. Iron padlock, from the Gate of Moultan, India, of similar construction to the Roman padlock (India Museum).
- Fig. 44c. Side view.
  - Fig. 45c. Side view of springs.
  - Fig. 46c. Side view of key.
- Figs. 47c and 48c. Modern iron padlock, from Cairo; the bolt entering a socket in the parallel bar.
- Fig. 47c. Longitudinal section.
  - Fig. 48c. End and side views of key.
- Figs. 49c and 50c. Modern padlock from Cairo; key with lateral action.
- Fig. 49c. Side view.
  - Fig. 50c. End view.
- Figs. 51c and 52c. Modern padlock from India; key with lateral action and ward; the bolt entering a socket in the parallel bar.
- Fig. 51c. Side view.
  - Fig. 52c. End view.
- Figs. 53c to 55c. Modern padlock, from Myhere, India (India Museum).
- Fig. 53c. Side view.
  - Fig. 54c. Longitudinal section.
  - Fig. 55c. Transverse section.
- Figs. 56c and 57c. Old Egyptian manacle.
- Fig. 56c. Side view.
  - Fig. 57c. Longitudinal section.

FIG. 39 c.

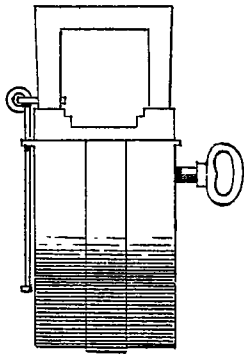

FIG. 40 c.

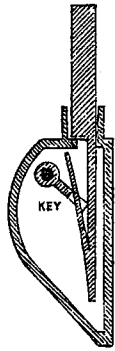

FIG. 41 c.

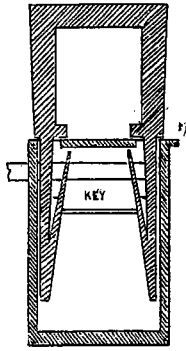

FIG. 42 c.

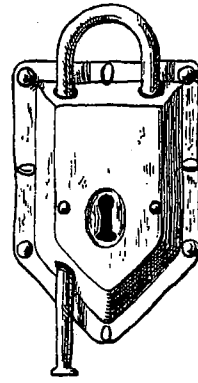

FIG. 43 c.



FIG. 46 c.



FIG. 44 c.

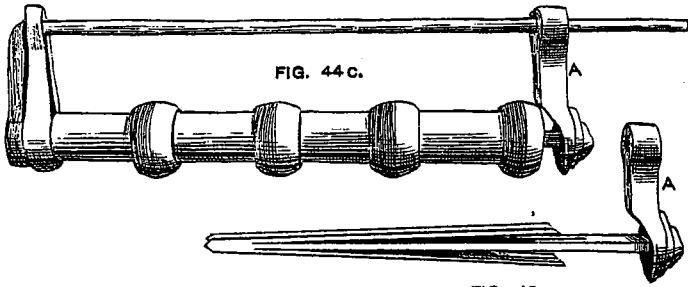

FIG. 45 c.



FIG. 47 c.

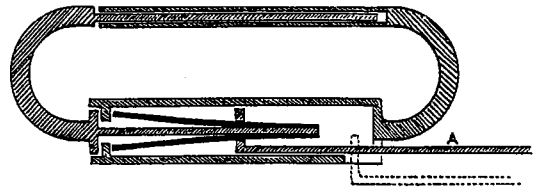

FIG. 48 c.

FIG. 49 c.

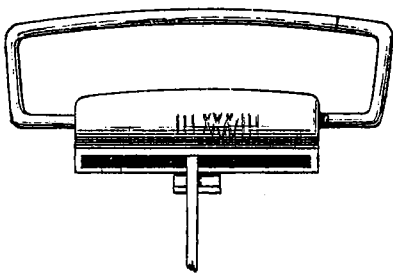

FIG. 50 c.

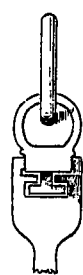

FIG. 51 c.

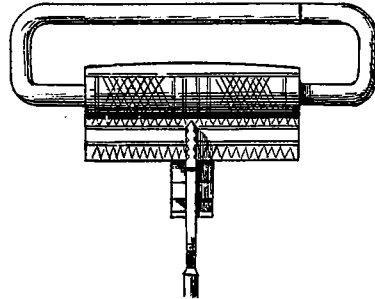

FIG. 52 c.

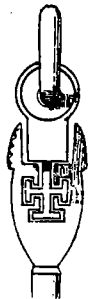

FIG. 53 c.

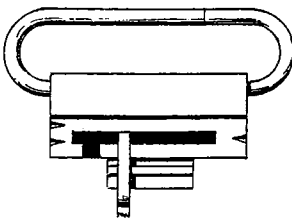

FIG. 54 c.

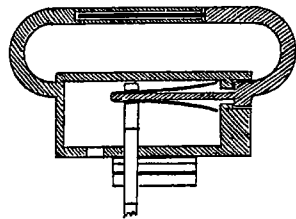

FIG. 55 c.



FIG. 56 c.

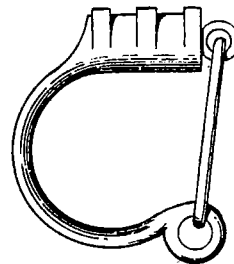
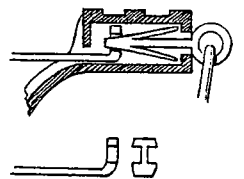

FIG. 57 c.



*On the Development and Distribution of Primitive Locks and Keys.*

PLATE VII.

Figs. 58c to 60c. Modern padlock, from Abyssinia (British Museum), the bolt entering a socket in the parallel bar.

Fig. 58c. Side view.

Fig. 59c. Side view of bolt and springs.

Fig. 60c. Front view of key.

Figs. 61c to 63c. Modern brass Chinese padlock.

Fig. 61c. Side view.

Fig. 62c. Side view of bolts and springs.

Fig. 63c. Transverse section.

Figs. 64c to 67c. Modern brass padlock, from Yarkand (India Museum).

Fig. 64c. Side view.

Fig. 65c. Side view of bolts and springs.

Fig. 66c. Transverse section.

Fig. 67c. Longitudinal section (looking down).

Figs. 68c to 70c. Modern steel lock, from Indore, India (India Museum).

Fig. 68c. Side view.

Fig. 69c. Longitudinal section.

Fig. 70c. End view (showing keyhole).

Figs. 71c to 74c. Modern steel lock, from India (India Museum).

Fig. 71c. Side view.

Fig. 72c. Longitudinal section.

Fig. 73c. End view.

Fig. 74c. End and side view of key.

FIG. 58 c.

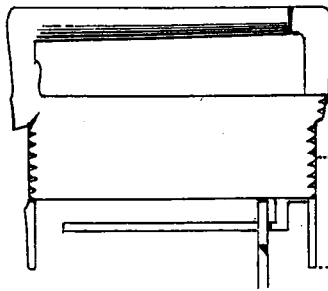

FIG. 59 c.

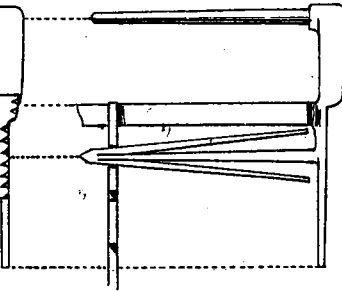

FIG. 60 c.



FIG. 61 c.

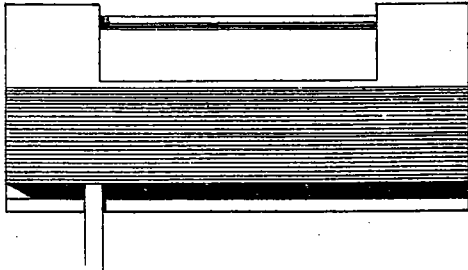

FIG. 62 c.

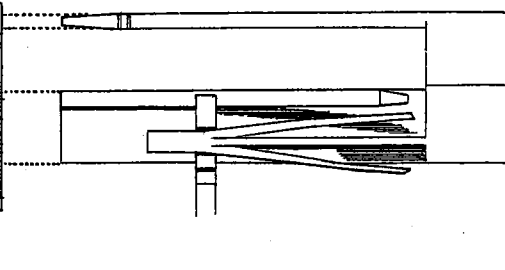

FIG. 63 c.

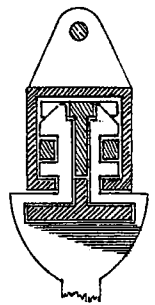

FIG. 64 c.

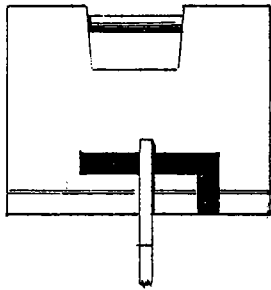

FIG. 65 c.

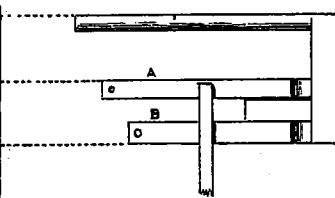

FIG. 66 c.

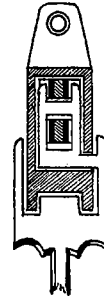

FIG. 67 c.

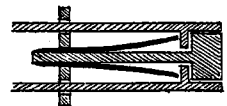

FIG. 68 c.

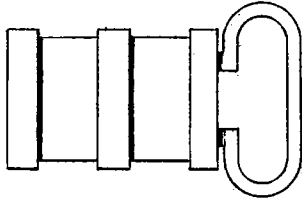

FIG. 69 c.

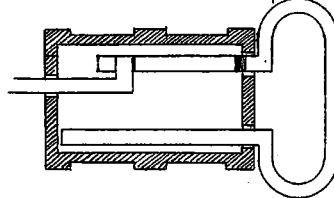

FIG. 70 c.

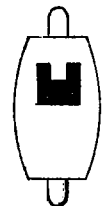

FIG. 71 c.

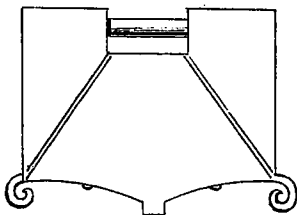

FIG. 72 c.

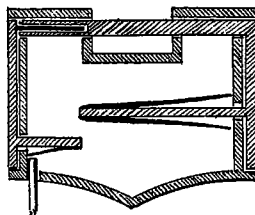
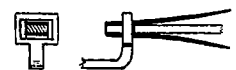

FIG. 73 c.



FIG. 74 c.



*On the Development and Distribution of Primitive Locks and Keys.*

PLATE VIII.

- Figs. 75c to 77c. Modern padlock from Burmah, with screw ward (India Museum).  
Fig. 75c. Side view.  
Fig. 76c. Longitudinal section.  
Fig. 77c. End view (showing keyhole).
- Fig. 78c. Portion of modern padlock from Nuremberg, with screw ward. End view, showing keyhole, with side and end views of key to same.
- Figs. 79c to 81c. Modern steel lock from Indore, India, with spiral spring action (India Museum).  
Fig. 79c. Side view.  
Fig. 80c. Longitudinal section.  
Fig. 81c. End view.
- Figs. 82c to 84c. Modern steel lock from India, with screw action (India Museum).  
Fig. 82c. Side view.  
Fig. 83c. Longitudinal section.  
Fig. 84c. End view.
- Figs. 85c to 89c. Modern iron lock from Brussels, with screw action.  
Fig. 85c. Side view.  
Fig. 86c. Longitudinal section.  
Fig. 87c. Side view of staple.  
Fig. 88c. End view of staple.  
Fig. 89c. Side view of key.
- Figs. 90c to 92c. Modern padlock from Toomkoor, Mysore, India, with spring action compressed by a revolving key (India Museum).  
Fig. 90c. Side view.  
Fig. 91c. Longitudinal section (looking down).  
Fig. 92c. Side view of key.

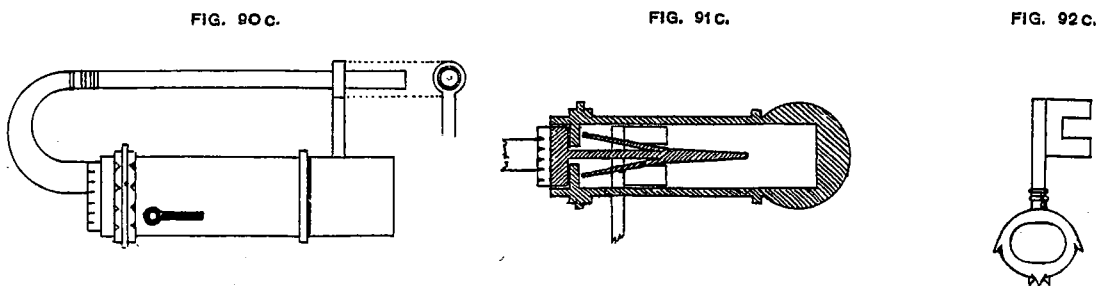
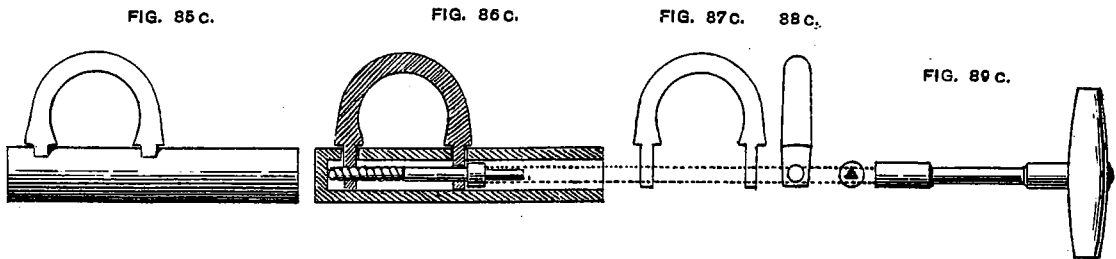
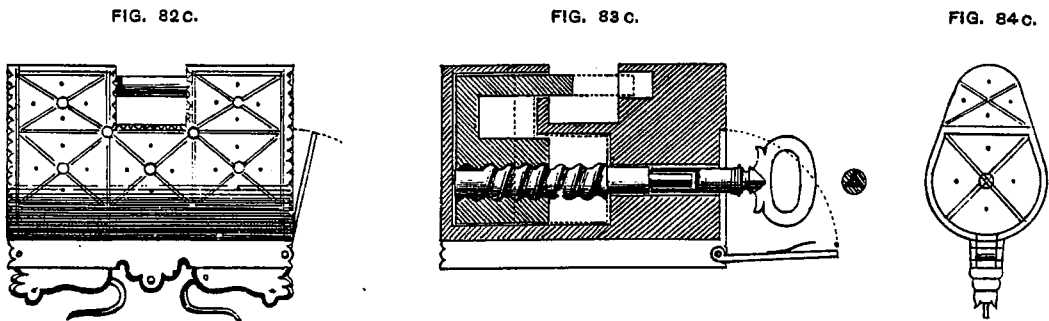
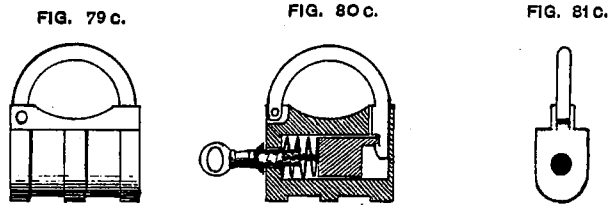
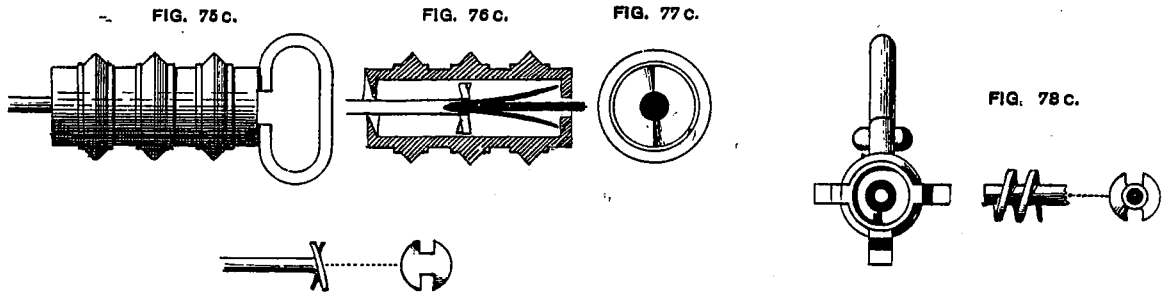

PLATE IX.

Figs. 93c to 97c. Modern Japanese brass padlocks.

Fig. 93c. Side view.

Fig. 94c. Side view of bolt and springs.

Fig. 95c. End view (showing keyhole).

Fig. 96c. Side and end view of key.

Fig. 97c. Side view (showing keyhole).

Figs. 98c and 99c. Modern Japanese brass padlock, the springs compressed by a revolving key.

Fig. 98c. Side view (showing keyhole).

Fig. 99c. End view, with side view of key.

Figs. 100c and 101c. Ancient bronze fish-shaped padlock ('La Ferronnerie'), believed to be from Egypt, in the Louvre, at Paris.

Fig. 100c. Side view.

Fig. 101c. Longitudinal section.

Figs. 102c to 104c. Modern steel fish-shaped padlock, from India (India Museum).

Fig. 102c. Side view.

Fig. 103c. Longitudinal section.

Fig. 104c. End view of key.

Figs. 105 and 106. Ancient Roman bronze lock, in the form of a horse, belonging to Dr. JOHN EVANS, F.R.S.

Fig. 105c. Side view.

Fig. 106c. End, showing apertures for springs.

Figs. 107c to 109c. Modern brass Chinese padlock in the form of a lion, the springs entering behind, belonging to Mr. CHUBB.

Fig. 107c. Side view.

Fig. 108c. Side view of bolt and springs.

Fig. 109c. Front view, showing method of inserting the key.

Fig. 110c. Front view of iron padlock from Cairo, also in common use in Naples at the present time.

Fig. 111. Revolving key for raising tumblers, found in London ('La Ferronnerie').

Fig. 112. Revolving key for raising two tumblers, found in Lothbury, London ('Archæological Journal').

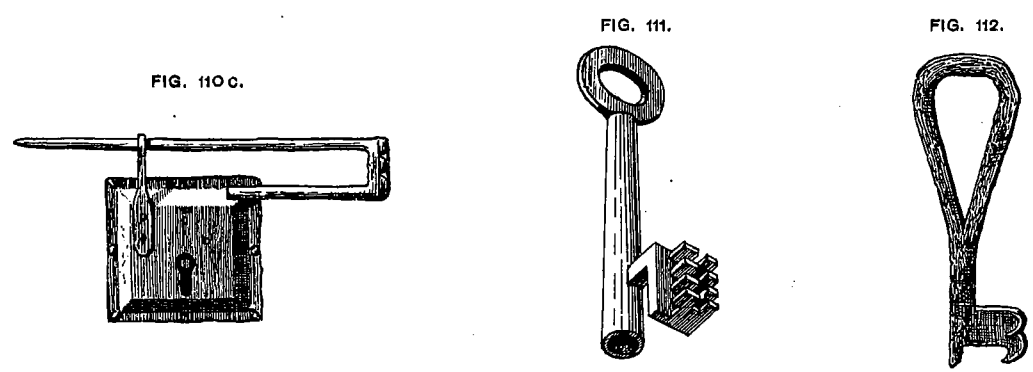
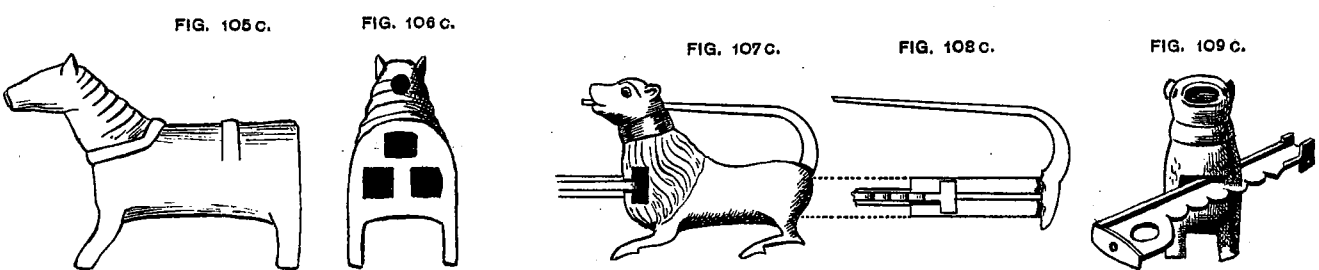
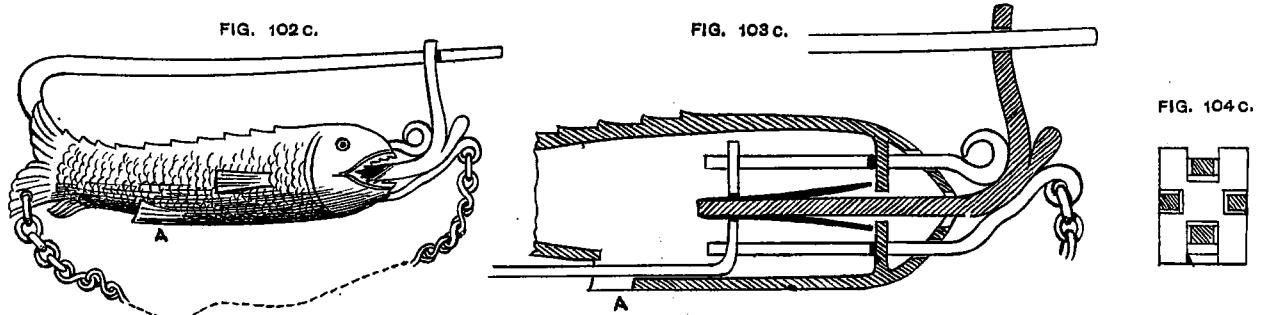
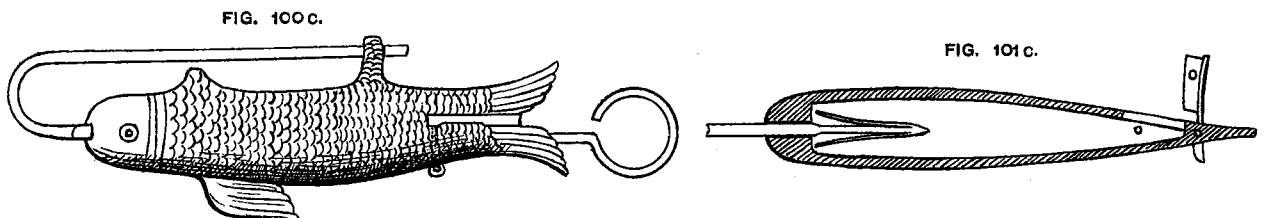
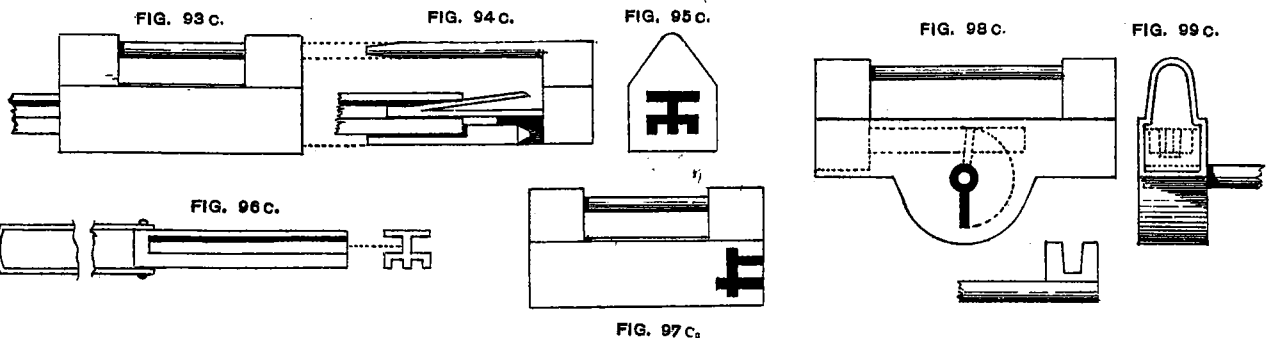



PLATE X.

- Figs. 113 to 116. Modern wooden tumbler lock, adapted to a revolving key, from India (India Museum).  
Fig. 113. Front view. A, bolt.  
Fig. 114. Longitudinal section.  
Fig. 115. Transverse section.  
Fig. 116. Key.
- Figs. 117 to 121. Modern wooden Chinese tumbler lock, the tumblers raised by a T-shaped key; the bolt shot with a revolving key, or handle, *a*.  
Fig. 117. Front view.  
Fig. 118. Transverse section, A B.  
Fig. 119. Longitudinal section.  
Fig. 120. Top view of bolt.  
Fig. 121. Top view of key.
- Fig. 122. Roman iron key, found in London.  
Fig. 123. Key from Chalons ('La Ferronnerie').  
Fig. 124. Key from Museum at Saumur ('La Ferronnerie').  
Fig. 125. Key from Museum at Saint Germain ('La Ferronnerie').  
Fig. 126. Modern English latchkey.  
Fig. 127. Lock with complex wards, used in the Middle Ages.
- Figs. 128 to 130. Modern tumbler lock found at Funtley, Hants, belonging to Mr. CHUBB.  
Fig. 128. Longitudinal section.  
Fig. 129. End view and section.  
Fig. 130. Top view of bolt.
- Fig. 131. BARRON'S tumbler lock (TOMLINSON 'On Locks and Keys').

FIG. 113.

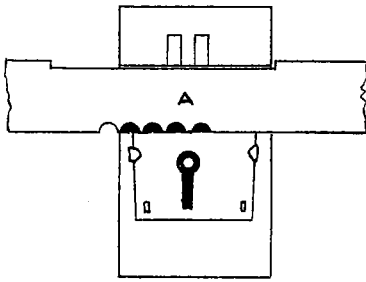

FIG. 114.

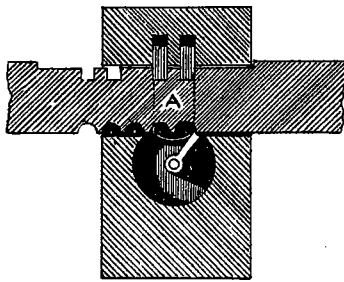

FIG. 115.

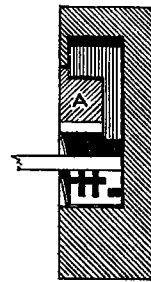

FIG. 116.

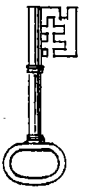

FIG. 117.

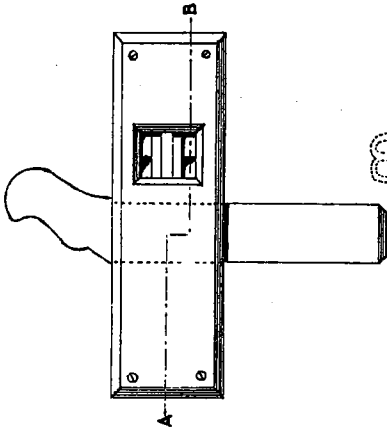

FIG. 118.

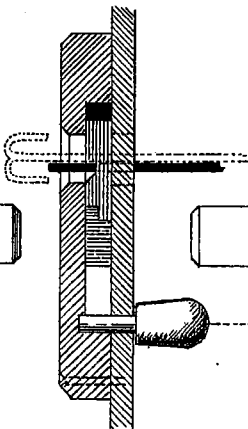

FIG. 119.

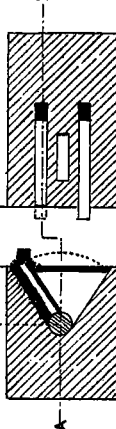

FIG. 120.



FIG. 121.



FIG. 122.

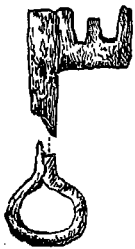

FIG. 123.



FIG. 124.



FIG. 125.



FIG. 126.



FIG. 127.

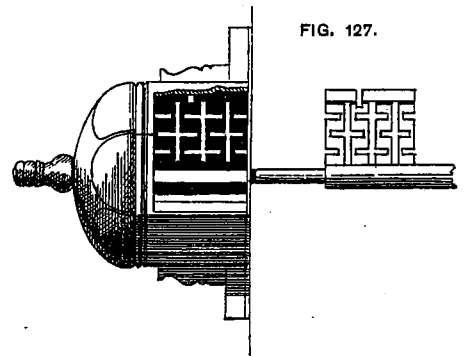

FIG. 128.

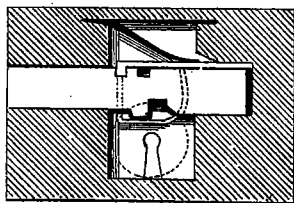

FIG. 129.

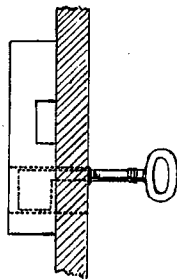

FIG. 131.

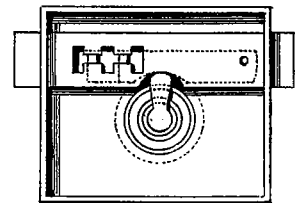

FIG. 130.

